

BAYCO *Golf*

GOLF COURSE ACCESSORIES

2024

Our Name Stands for *Quality*

Bayco Golf has been an industry leader in golf course accessories since 1986. Our products are found on the most prestigious golf courses all around the world! With almost 40 years of experience and our diverse line of products, we can meet the needs and outfit any type or size of golf course. No job is too big or small – whether you are constructing a 36-hole resort course or a small putting green in your back yard, we have what you are looking for!

Get on course with **BAYCO!**

Call us today to place your order 1 (877) 668-4653

Featured Products

Bayco Golf proudly sources more than 95% of its products from North American manufacturers and suppliers.



Top Notch Hole Paint
p. 29



Detergent Soap Tablets
p. 8



Armoured Rake Handle
p. 42



InstaFix Repair Tool
p. 43

Featured Products

IMPROVED PRICING!



Model 700 Ball Washer
p. 5

IMPROVED PRICING!



Model 699 Ball Washer
p. 5

NEW!



White Plastic Cup Collar
p. 29

IMPROVED PRICING!



Green Plastic Cup Cover
p. 32

IMPROVED PRICING!



Range Club Washer
p. 64

IMPROVED PRICING!



Bayco Laser Reflectors
p. 36



Bayco Golf proudly sources more than 95% of its products from North American manufacturers and suppliers.

TABLE OF CONTENTS



PRACTICE AREA
P. 54-59



DOWN THE FAIRWAY
P. 18-23

PRO SHOP

CLUB HOUSE

DRIVING RANGE

100

150

200

250

300



COURSE SIGNAGE
P. 40-47



PRO SHOP & CLUB HOUSE
P. 60-64



AROUND THE GREEN
P. 24-39



TEE BOX AREA
P. 1-17

MAINTENANCE



GOLF COURSE TOOLS
P. 48-53



CLEARANCE
P. 65-67

Detailed Table of Contents on the Next Page

ASK US ABOUT...



Custom Flags

Our custom flags will not disappoint! We have several fabric and sizes to choose from. More information on p. 34

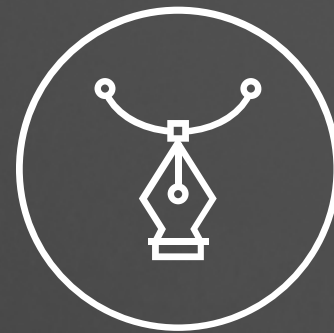

Illustration Services

If your logo is outdated or you don't have the proper files - we've got you covered! We offer drawing and re-tracing services. Please contact us for more information.



Golf Tournament Accessories

Bayco Golf loves tournaments! Let us help you with the custom designs of your golf course accessories.



Design Inspiration

Bayco Golf can help you with the design ideas for your custom items.



Customized Ball Washers

Our Model 700/770 plunger style ball washer has the added ability to include a custom decal.



Custom Signage

We offer several different signage styles and materials. For more information, please go to p. 40.

Table of Contents

TEE BOX AREA

BALL WASHER ENSEMBLES	3
PLUNGER STYLE BALL WASHERS	5
CRANK STYLE BALL WASHERS	6
ENSEMBLE ACCESSORIES	6
ALUMINUM CLUB WASHERS	8
DETERGENT	8
DIVOT MIX CONTAINERS	10
SAND AND SEED BOTTLE RACK	10
SAND AND SEED BOTTLES	11
LITTER BASKETS	12
DESIGNER SERIES LITTER BINS	13
TEE TOWELS	14
WATER COOLER ACCESSORIES	14
BENCHES	15
BROKEN TEE CADDIES	16
ALUMINUM TEE MARKERS	17
PLASTIC TEE MARKERS	18

DOWN THE FAIRWAY

COLOR FLEX MARKERS	23
FAIRWAY DISTANCE & HAZARD MARKERS	23
BRAIDED & BUNGEE ROPE	24
ROPE STAKES	24
PAINT AND MARKING TOOLS	25

AROUND THE GREEN

HOLE CUTTERS	28
CUP PULLERS	29
TRIMMERS	29
TOP NOTCH HOLE PAINT	29
WHITE PLASTIC CUP COLLAR	29
ALUMINUM CUPS	30
PLASTIC CUPS	30
ALUMINUM PRO-HOLE CUPS	31
CUP LINERS	31
CUP ACCESSORIES	32
REGULATION 1/2" POLES	34
REGULATION SMARTY STICKS	34
TAPERED TOURNAMENT 3/4" POLES	35
TOURNAMENT SMARTY STICKS	35
REFLECTORS	36
FLAGPOLE RESTORATION	36
COURSE FLAGS	38
SPECIALTY FLAGS	38
FLAG ACCESSORIES	38
CUSTOM FLAGS	41
RAKE HEADS	42
RAKE HANDLES	42
COMPLETE RAKES	42
COCO DRAG MAT	43
GREENS TOOLS	43
BALL MARK REPAIR TOOL	43

COURSE SIGNAGE

CAST IN MOLD CUSTOM SIGNAGE	46
RECYCLED PLASTIC CUSTOM SIGNAGE	48
CAST IN MOLD GROUND TEE MARKERS	49
RECYCLED PLASTIC EASELS	49
ACP CUSTOM SIGNAGE	50
HEAVY DUTY SIGNAGE	52
ALUMINUM & DIRECTIONAL SIGNAGE	53

COURSE TOOLS

SOIL SAMPLERS	56
AERATORS	57
SPRINKLER HEAD TRIMMERS	58
LANDSCAPERS AND SQUEEGEES	58
OTHER MAINTENANCE TOOLS	59

PRACTICE AREA

PRACTICE GREENS MARKERS	62
PRACTICE GREENS POLES AND BASES	62
PRACTICE GREENS FLAGS	63
RANGE FLAGS	63
RANGE CLUB WASHERS	64
CHIPPING GREENS BALL PUSHER	64
RANGE BANNERS	65

PRO SHOP & CLUBHOUSE

SPIKE CLEANER STANDS AND MOUNTS	68
REPLACEMENT BRUSHES & ASSEMBLIES	68
OTHER FURNITURE	69
ECO BLAST AIR HORNS	69
PROXIMITY MARKERS	70
UNIVERSAL FLAG HOLDER	70

CLEARANCE

71

ABOUT BAYCO

73

INDEX

74

TEE BOX AREA

TEE BOX AREA



Tear Drop Marker
Part No. 816BL
Page 12

Model #700 Ball Washer
Part No. 700GR
Page 5

Designer Series Litter Bin
Part No. 765GR
Page 13

Recycled Plastic Bench
Part No. EE1214
Page 15

BALL WASHER ENSEMBLES	3
PLUNGER STYLE BALL WASHERS	5
CRANK STYLE BALL WASHERS	6
ENSEMBLE ACCESSORIES	6
ALUMINUM CLUB WASHERS	8
DETERGENT	8
DIVOT MIX CONTAINERS	10
SAND AND SEED BOTTLE RACK	10
SAND AND SEED BOTTLES	11
LITTER BASKETS	12
DESIGNER SERIES LITTER BINS	13
TEE TOWELS	14
WATER COOLER ACCESSORIES	14
BENCHES	15
BROKEN TEE CADDIES	16
ALUMINUM TEE MARKERS	17
PLASTIC TEE MARKERS	18

ENSEMBLES



Completely customizable with any of our interchangeable ensemble components. Mix and match colors, towels, can lids, ball washers and more!

ENSEMBLES



Don't forget to ask us about customizing your ensemble with your course logo. The combinations and possibilities are endless!

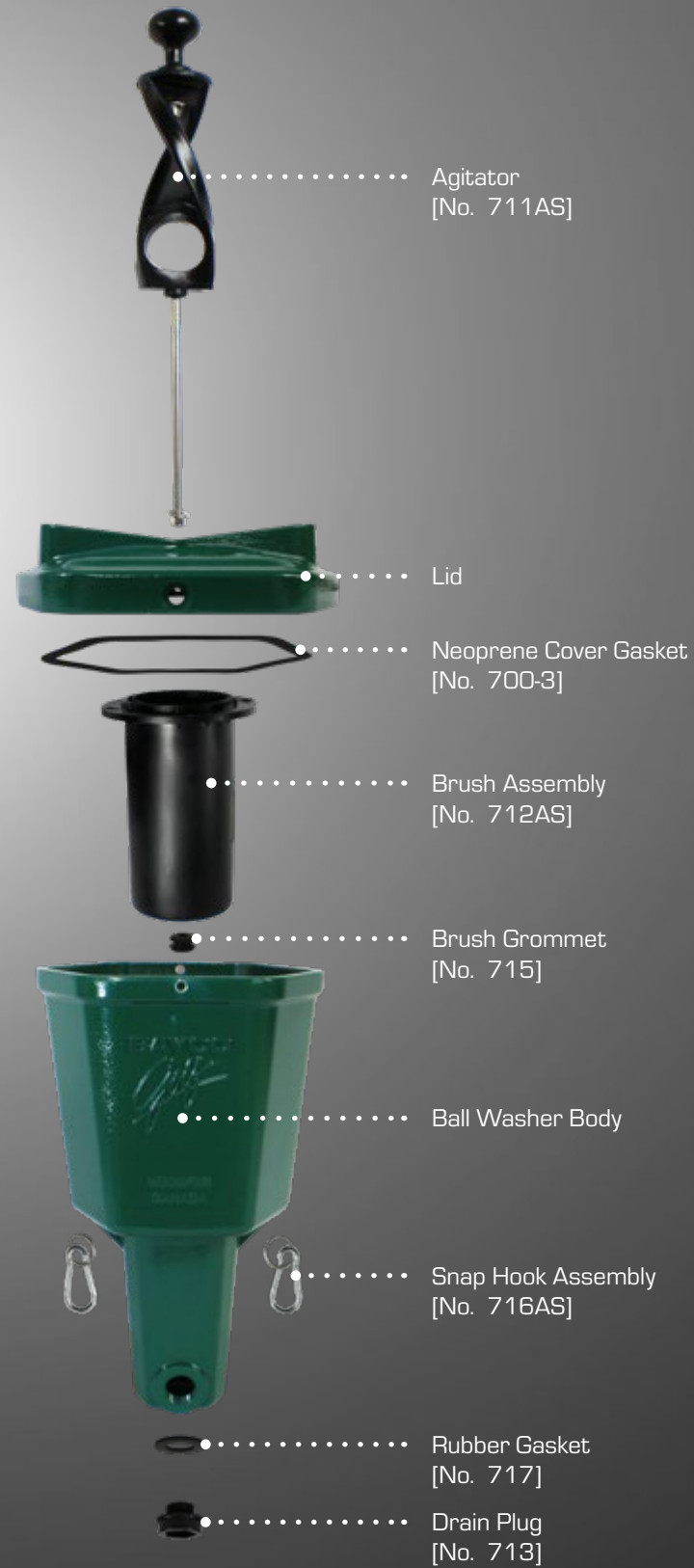

PLUNGER STYLE BALL WASHERS INCLUDED:

All of our plunger style ball washers are made of cast-in-mold aluminum alloy and feature durable polymer and stainless steel internal components, providing years of trouble free service.

- Green ● Red ● Black ● Copper Vein

* Custom colors are available.

* Minimum Order of 20 for Copper Vein



Plunger Style Ball Washer [No. 700]

Our signature ball washer.
Capacity: 7.2 US Pints/3.4L
Cleans 1 ball at a time.

INCLUDED:

- Easy grip replaceable agitator knob
- Flanged cover does not seize and is easy to remove
- Brush assembly firmly fastened underneath cover with stainless steel cap screws
- Powder coated color finish ensures durable and beautiful color for years



Plunger Style Ball Washer [No. 699]

Our smaller model is manufactured to the same quality as the 700 ball washer.
Capacity: 5 US Pints/2.37L
Cleans 1 ball at a time.

* Minimum Order of 20 for Copper Vein



Customizable Ball Washer [No. 770]

Our Model 700 ball washer with added ability for custom logo*
Capacity: 7.2 US Pints/3.4L
Cleans 1 ball at a time.

** Minimum order: 9 for red, green and black; 18 for copper vein



TEE BOX AREA

CRANK STYLE BALL WASHERS

- Easy lift cover with hinges
- Powder coated color finish (glass hard) ensures durable and beautiful color for years
- Unique brush style cleans more than one ball at a time
- Features **NEW** handle design!

* Minimum Order of 20 for Copper Vein

● Green ● Red ● Black ● Copper Vein



Crank Style Ball Washers [No. 778]

Manufactured to the same quality as all of our ball washers, this model is able to clean multiple balls at a time.
Capacity: 7.2 US Pints/3.4L
Cleans 4 balls at a time.



ENSEMBLE ACCESSORIES

Stand Pipes are made of aluminum and powder coated black.
ID 2 1/8"; OD 2 3/8".

*Pipes sold separately in black only.

The stand base made of cast aluminum and has powder coated finish.
**Spikes sold separately.

● Green ● Red ● Black ● Copper Vein * Custom colors are available.
* Minimum Order of 20 for Copper Vein



1. 34" Stand Pipe [No. 702BK-34]

The 34" pipe is for the 701 base.

2. 46" Stand Pipe [No. 702BK-46]

The 46" pipe is for direct burial.



Ball Washer Stand Base [No. 701]

The Stand Base acts as a universal base unit for all of our ball washer Ensembles.

BALL WASHER REPAIR KITS

Everything you need to bring your ball washer back to life! The repair kit fits all quality brand plunger style units. Includes all parts listed below; they are also sold separately.



Plunger Style Repair Kit [No. 721KIT]

1. Snap Hook Assembly [No. 716AS]

Complete with stainless steel key rings which hook onto the ball washer. They allow you to add a tee towel to your ensemble.

2. Rubber Drain Plug Gasket [No. 717]

Used to tighten and remove the drain plug.

3. Drain Plug Wrench [No. 714]

Used to tighten and remove the drain plug.

4. Drain Plug [No. 713]

Used to tighten and remove the drain plug.

5. Allen Keys [No. 714-1 (5/32" cal.)]

[No. 714-2 (3/16" cal.)]

6. Brush Assembly [No. 712AS]

Used to clean the balls.

7. Agitator Assembly [No. 711AS]

Used to agitate the balls.

TEE BOX AREA

Includes all parts listed below (also sold separately).



Crank Style Repair Kit [No. 779KIT]

1. Brush Holder Assembly [No. 777-3]

Used to hold the brush.

2. Complete Handle [No. 777-4]

Used to operate the ball washer.

Secures the base to the ground.
Sold in sets of three.
Size: 5/16 - 18NC, 4" long, 3/8"



4" SS Spikes for 701 Base [No. 801-3]

Attaches to the 701 base. Sold individually.
Measures 5.25"x5.75"



Foot Brush w/ Screws [No. 610]

Allows the ball washers to be attached to any wall. Works with the aluminum club washers, as well. Hardware not included due to wide variety of wall materials.
Sold in black only.



Ball Washer Wall Mount [No. 692BK]

ALUMINUM CLUB WASHERS

Durable, cast-in-mold aluminum alloy and powder coated inside and out, this tough club washer provides many years of care-free service. Includes two easily replaceable scrub brushes and a 3/4" drain plug.

● Green ● Red ● Black ● Copper Vein



Aluminum Club Washer [No. 690]

Two brushes per Club Washer. Sold individually. Available for 2023.



Replacement Brush [No. 690-3]

Works for hard and soft surfaces, simply install with 4 spikes or bolts. Made with cast aluminum and powder coated finish. Comes complete with a 2x6" black aluminum pipe.

● Green ● Red ● Black



Club Washer Flanged Base [No. 650]

DETERGENT

Our liquid and tablet detergents leave the balls, ball washers and club washers sparkling clean and debris free.



Detergent Soap Tablets [No. 718T]

500g/container. One tablet per ball washer fill. Convenient and portable.



Heavy Duty Detergent [No. 718]

4L container. Mix 1 part concentrate to 4 parts water



TEE BOX AREA

DIVOT MIX CONTAINERS

These maintenance free polyethylene containers are ideal for your tee or range areas. The lid is engineered to keep your mix dry and provide easy access.

● Brown* ● Green ● Black

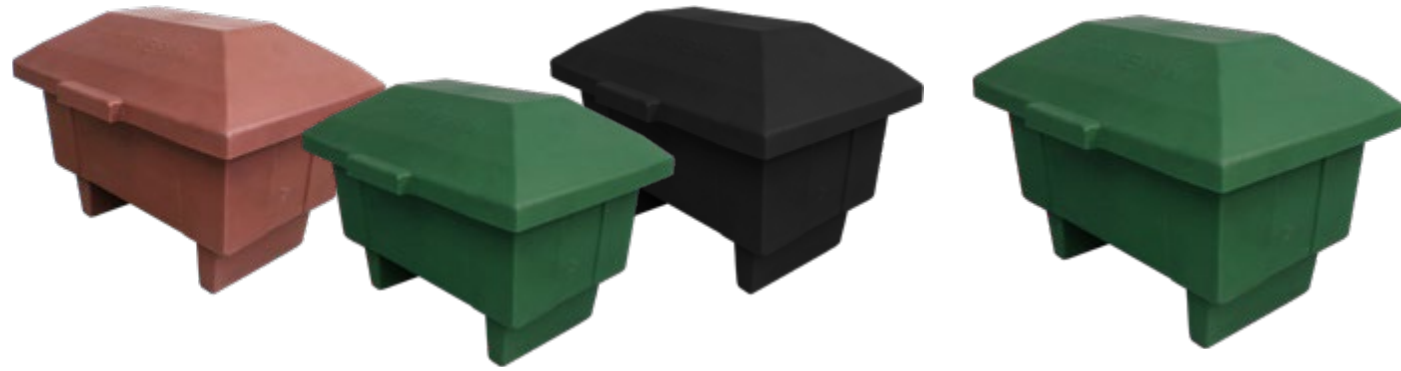

Divot Mix Container (M) [No. 696]

16.8L Capacity; 16 oz plastic scoop included with every container.
Approx. Size (LxWxH): 19.5"x14"x16"

*While Quantities Last

Divot Mix Container (L) [No. 697]

42.4L Capacity; 16 oz plastic scoop included with every container.
Approx. Size (LxWxH): 23.5"x16"x18"

Simple, ergonomic, polyethylene plastic scoop for your divot mix container



8 oz Plastic Scoop [No. 233BK-08] 16 oz Plastic Scoop [No. 233WH-16]

A 16 oz scoop is included in every Divot Mix Container.

SAND AND SEED BOTTLE RACK

Rear handle for easy push or pull of the rack.

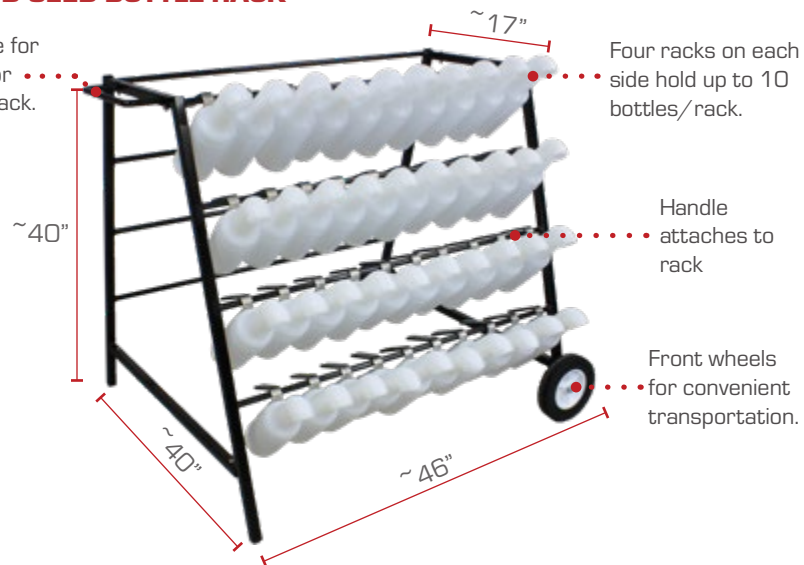

Four racks on each side hold up to 10 bottles/rack.

Handle attaches to rack

Front wheels for convenient transportation.

Sand and Seed Bottle Rack [No. 243]

Convenient mobile rack, holds up to 80 bottles.* Ships flat for economy, assembles easily.
*Bottles sold separately.

TEE BOX AREA

SAND AND SEED BOTTLES

Our sand and seed bottles have a screw on/off bottom lid with wide opening for easy filling. Made of heavy duty plastic. Ergonomically designed for easy transportation and with narrower base, these bottles fit in any bottle holder.

Made to the same quality as all of our sand and seed bottles, this bottle is complete with a molded in handle.



Rattle Proof Sand and Seed Bottle [No. 234R]

1.3L Capacity



Rattle Proof Sand and Seed Bottle with a Metal Handle [No. 234H]

1.3L Capacity; attaches to the bottle rack Replacement Bottle Handle Assembly [No. 234AS]



Rattle Proof Sand and Seed Bottle with Molded In Handle [No. 234HR]

1.3L Capacity; Built-in handle

A slimmer solution with an air tight lid that pops on and off for easier refill and a clip which allows it to snap onto any golf bag.



1. Personal Sand and Seed Bottle [No. 234P]

0.5L Capacity

2. Replacement Parts for 234P [No. 234P-KIT]

Replacement bottom cap, top lid, and clip.

SAND AND SEED BOTTLE ACCESSORIES

Attach the Sand & Seed bottles to virtually any cart. Please contact us for a quote.

Our screw-on caps fit all of our Sand and Seed Bottles.



Rattle Proof Design



Sand and Seed Bottle Holder [No. 245]

Bottle holder for flat bottom (245) or rattle proof bottom (245U) Sand & Seed bottles. They are also available with attachment hardware for Yamaha, E-Z-Go, and ClubCar golf carts.



3. Replacement Screw-On Cap with Flat Bottom [No. 234H-3]

Fits the 245 bottle holder only.

4. Replacement Screw-On Rattle Proof Cap [No. 234R-1]

Fits all bottles and bottle holders.

LITTER BASKETS

The litter baskets are available in 9 gal size and in three different colors*. Made with 20 gauge steel and with powder coated finish. Available in three different bases to fit your application requirements.

● Green ● Red ● Black

* Custom colors are available upon request. Minimum order applies, please contact us.



Litter Basket with Spike Base [No. 750]

Perfect for installing into a soft surface, such as grass.

Litter Basket with Flat Base [No. 754]

Sturdy base for any application.

Litter Basket with Cone Base [No. 755]

Sturdy base for any application.

Bases available only in black

LITTER BASKET BASES



- 1. Steel Spike Base [No. 750-5]
- 2. Flat Base [No. 759]
- 3. Cone Base [No. 760]

LITTER BASKET ENSEMBLE ATTACHMENTS



- Stand Base Mount [No. 745]
- Attaches to the 701 base stand in the same fashion as the 610 foot brush.

DESIGNER SERIES LITTER BINS

Made of strong polyethylene plastic, these litter bins and lids are ergonomically designed to add elegance to both the ball washer ensemble and on their own. Lids sold separately.



- 1. Trash Lid Opening [No. 766T]
- 2. Solid Lid (No Opening) [No. 766S]
- 3. Can Lid Opening [No. 766C]
- Sold in black only.



Designer Series Litter Bin [No. 765]

All stands are made of aluminum and powder coated black.

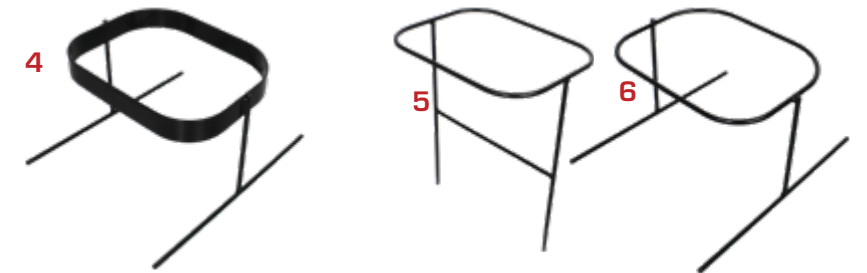

- 4. Above Ground Stand [No. 748C] WQL

- 5. In-ground Stand [No. 748B]
- 6. Above Ground Stand [748D]

LITTER BIN ENSEMBLE MOUNTING BRACKETS

Mounts are made of aluminum and powder coated black. They wrap around a 2" Ensemble Pipe and can support one or two Litter bins. All necessary hardware included.



Double Mounting Bracket [No. 747BK]

Single Mounting Bracket [No. 746BK]

TEE BOX AREA

TEE TOWELS

Smooth cotton fibers deliver a light, thin, fast drying fabric. Sold in green only. 12 towels/pkg.



Cotton Corner Grommet Tee Towel [No. 725GR]

100% cotton with smooth cotton threads producing a very soft feel. Sold in black & green. 12 towels/pkg. Embroidery available, please contact us.



Elite Cotton Center Grommet Towel
Black Towel [No. 730BK]
 Replacement for No. 731BK
Green Towel [No. 730GR]

Smooth cotton fibers deliver a light, thin, fast drying fabric. Sold in green and black. 12 towels/pkg.



Tri-Fold Cotton Central Grommet Towel
 Green Towel [No. 731GR]
 Black Towel [No. 731BK]
 [No. 730BK] is our replacement, better quality

WATER COOLERS

Soft, absorbent, and strong disposable Corner Grommet Tee Towels. 200 towels/pkg.

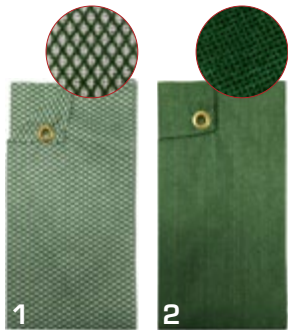

1. Classic Tee Towel [No. 728GR]
2. Premium Tee Towel [No. 729GR]

The Igloo water coolers are easy to transport and are made of sturdy, heavy-duty plastic. The inner layer is insulated which keeps liquids cool longer, even on hot days.



10 Gal. Water Cooler [No. 282G]
 Replacement liners available [No. T1000 - 50/box]; not included, sold separately



5 Gal. Water Cooler [No. 281]

BENCHES

All benches made with 2"x6" ultraplant recycled plastic for longevity and durability. Ships flat for economy and convenience. All necessary hardware included.



Grey Redwood Green



5' Deco Bench

- Grey [No. EE1170]
- Redwood [No. EE1179]
- Green [No. EE1174]
- Tan [No. EE1178]



Grey Redwood Green



6' Deco Bench

- Grey [No. EE1190]
- Redwood [No. EE1193]
- Green [No. EE1194]
- Tan [No. EE1198]



Grey Redwood Green



6' Standard Bench

- Grey [No. EE1210]
- Redwood [No. EE1213]
- Green [No. EE1214]
- Tan [No. EE1218]

WATER COOLER ACCESSORIES

All accessories made of premium material. Easy to install and replace any broken parts. Sold individually. Some assembly required.

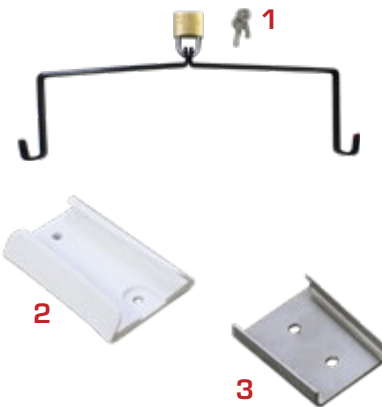

1. Lock and Key [No. 282C]
2. Plastic Bracket [No. 282CLIP]
3. Steel Bracket [No. 279-4]



4. Lever Style Spigot [No. 282]
5. Pinch Tube Spigot [No. T600]
6. Push Button Spigot [No. 282SPIG]

Dispensers can hold approx. 200 solo cups* at a time. They come complete with a mounting bracket that attaches easily to our water coolers.

*Sold separately



7. Steel Cup Dispenser [No. 283]
8. Plastic Cup Dispenser [No. 283P]
9. 4 oz Solo Cups [No. 288]
 Sold in cases of 5,000 only.

TEE BOX AREA

BROKEN TEE CADDIES

They act as distance markers and as receptacles for broken tees.

Made of durable plastic material and color impregnated through allows for an economical and lasting tee caddy. Stainless steel spike included.



Plastic Broken Tee Caddy [No. 815]

Measures H: 6" (without spike)
W: 5" Diameter

- Red ○ White
- Blue ● Yellow



- Red ○ White ● Blue
 - Yellow ● Green ● Black
- *Custom colors are available.

Aluminum Broken Tee Caddy [No. 808]

Made of cast aluminum and powder coated. 3.5" SS spike included.
Raw/Unfinished Caddies are available.
Measures H: 4.5" (without spike)
W: 5.5" Diameter



Made of recycled plastic lumber, this caddy has a steel mesh base for drainage.

Recycled Plastic Broken Tee Caddy [No. E803GR]

Measures (HxWxL): 3.5"x6.75"x10"

TEE BOX AREA



ALUMINUM TEE MARKERS

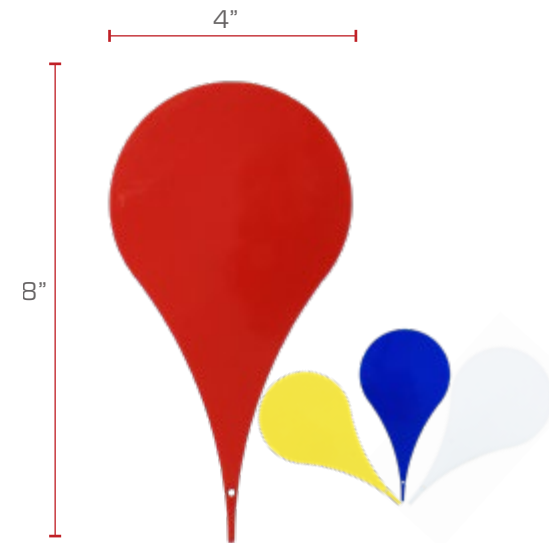

- Red ○ White ● Blue ● Yellow

Made of 1/8" thick steel with powder coated finish. Custom decals and colors are available.

Tear Drop Tee Marker [No. 816]

Raw/Unfinished Markers are available.
Custom decal available - Call for quote.



- Red ○ White ● Blue
- Yellow ● Green ● Black

Made of aluminum with powder coated finish. Each marker comes complete with a stainless steel spike.

Solid Aluminum Tee Marker [No. 820]

Raw/Unfinished Markers are available.
*Custom colors are available.

PLASTIC TEE MARKERS

These markers are made of durable polyethylene plastic material. The color is impregnated for longevity. Each marker is completed with a metal spike.



3" Solid Plastic Tee Marker [No. 810]



5" Solid Plastic Tee Marker [No. 812]



5" Hollow Plastic Tee Marker [No. 811]

PLASTIC TEE MARKERS



Our 5" hollow plastic tee marker, but with molded in plastic base.

Red White Blue Yellow

5" Hollow Tee Marker w/ Plastic Base [No. 814]



Our 5" solid plastic tee marker, but with the added bonus for a customized decal. Clearance.

Red Blue
Yellow Black

5" Custom Solid Tee Marker [No. 813]



Made of recycled plastic, this solid cube marker measures 4"x4"x4" and comes complete with a steel spike.

Red White
Blue Yellow Black

Recycled Plastic Cube Tee Markers [No. E800]

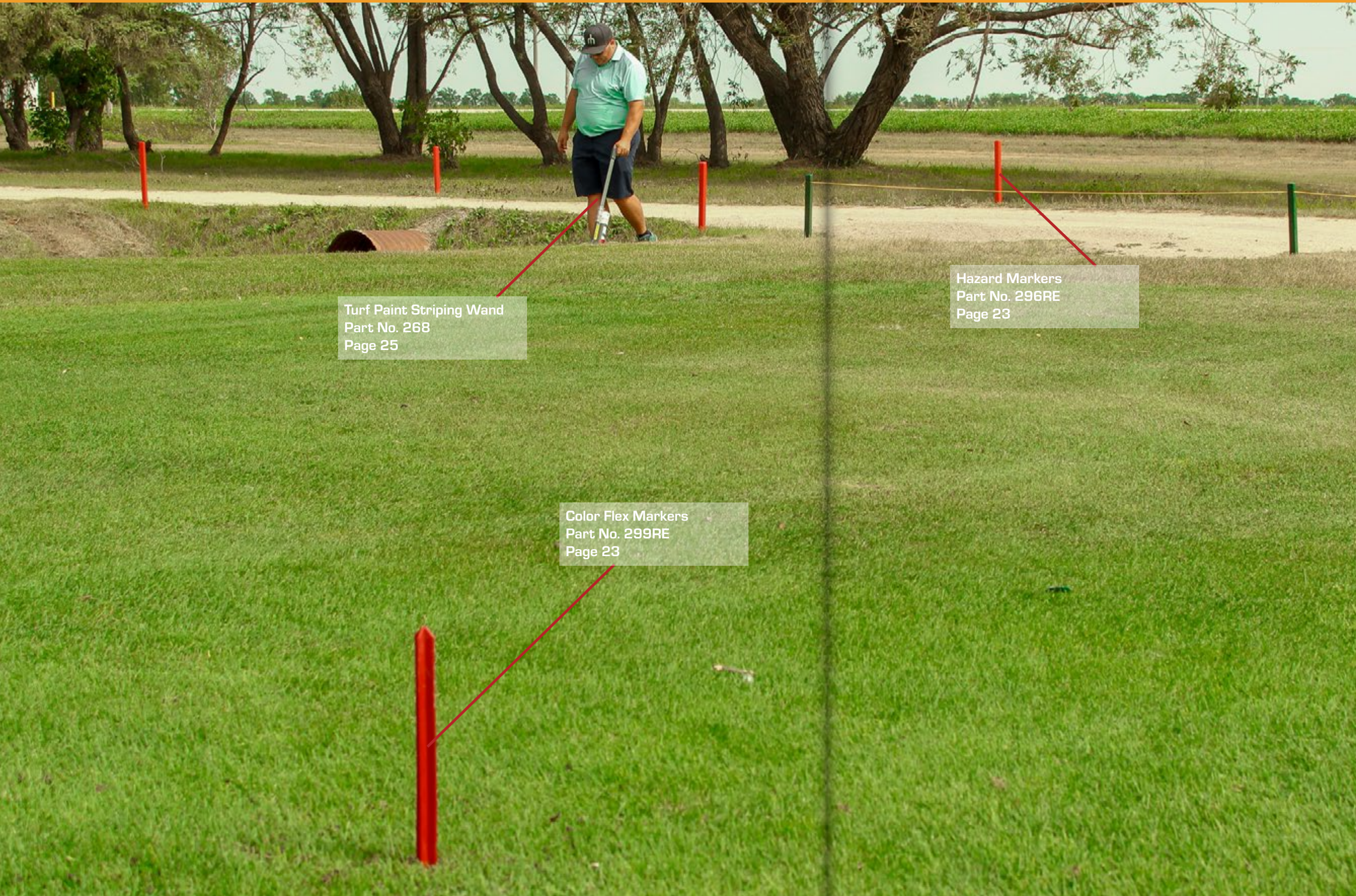

Turf Paint Striping Wand
Part No. 268
Page 25

Hazard Markers
Part No. 296RE
Page 23

Color Flex Markers
Part No. 299RE
Page 23

COLOR FLEX MARKERS	23
FAIRWAY DISTANCE	23
HAZARD MARKERS	23
BRAIDED & BUNGEE ROPE	24
ROPE STAKES	24
PAINT AND MARKING TOOLS	25

COLOR-FLEX DISTANCE MARKERS

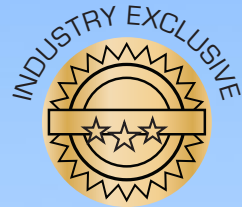

- HIGHLY VISIBLE, NON INTRUSIVE, PERMANENTLY COLORED STAKES
- SUPREME DURABILITY AND RESILIENCE IN EXTREME TEMPERATURE CHANGES
 - THE **ONLY** FLEXIBLE DISTANCE MARKERS
- WITHSTANDS CROSS CUT OR DIAGONAL MOWING IN **ANY** DIRECTION
 - SPEEDS UP GAME PLAY AND MOWING TIMES
 - EASY 2-STEP INSTALLATION
 - 6 MONTHS WARRANTY
- REPLACEMENT MARKERS AND INSTALLATION KITS ARE AVAILABLE



Step 1: Continue mowing without getting off to take out the markers.
Step 2: There is no step 2.



COLOR FLEX MARKERS

The ColorFlex Fairway Distance Marker is an industry exclusive item that was designed to eliminate the removal of markers while mowing - one of the most bothersome tasks for superintendents. Speed up your mowing times by simply mowing over them.

- Blue
- White
- Red
- Yellow
- Green
- Orange

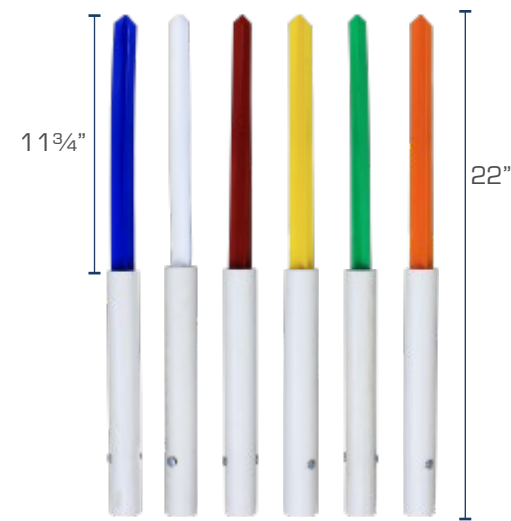

Color Flex Distance Markers [No. 299]

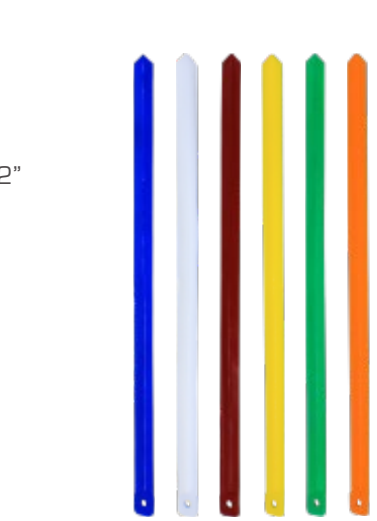

Replacement Markers [No. 299-01]

The kit includes everything you would need to install your ColorFlex markers quick and effortlessly. Sold separately, as well.



Installation Kit [No. 299KIT]

- Rubber Mallet [No. 299MAL]
- Drill Bit [No. 299BIT]
- PVC Tube Extension [No. 299TUBE]

FAIRWAY DISTANCE AND HAZARD MARKERS

Cast aluminum distance marker with a powder coated finish. Comes complete with a 6" stainless steel spike.

Made of heavy duty polymer, these domed distance markers come complete with a 6" stainless steel spike.

- Red
- Blue
- Black
- White
- Yellow



Domed Aluminum Distance Marker [No. 573]



Domed Polymer Distance Marker [No. 571]

Appropriately color coded for OB (white) & water (red & yellow) hazards to reference areas on the golf course. Can also be used as distance markers. Size: 24"

- Red
- White
- Blue
- Yellow



Recycled Plastic Hazard Markers [No. 296]

BRAIDED ROPE

Made of durable polypropylene material, this braided rope is 1/4" in diameter, waterproof and resists rot, oil and other chemicals. Hollow braid is super flexible with a smooth diamond weave.

-  White/Green
-  Yellow
-  Green
-  White
-  Black



Three Strand Braided Rope
Available length: 1000 ft spools [No. 287]

ROPE STAKES

Made of recycled color impregnated plastic with stainless steel spike.
Speed slot - 5mm, drilled hole - 12mm

-  Black
-  Green
-  Red
-  White
-  Blue
-  Yellow



Recycled Plastic Rope Stakes (No. 289)

Length	Item Number
15"	289-15
18"	289-18
24"	289-24

BUNGEE ROPE

Made of quality flexible material that maintains elasticity even in cold climates and prevents the pulling out of the stakes if encountered. The rope remains taut and will not sag.

-  Yellow
-  White/Green
-  Green
-  Black



Bungee Rope [No. 400]
Available lengths: 250 ft and 500 ft

250 ft spool [No. 400-250]
500 ft spool [No. 400-500]

Choose a size (30" or 36") and the amount/ location of speed slots. Comes in green. (Other colors and sizes are available upon request).

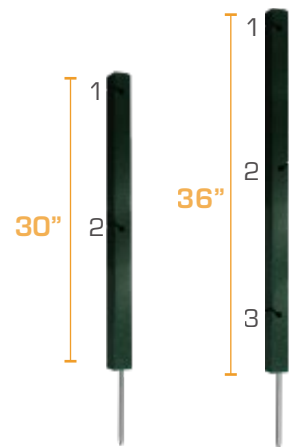

Custom Rope Stake [No. 289-CUSTOM]

PAINT AND MARKING TOOLS

No more bending, simply insert the turf paint in the wand, point towards the ground and start walking. The wheel on the bottom allows for smooth glide without stopping or jerking. Applying straight lines has never been easier!



Marking Wand [No. 268]

A handheld alternative to the marking wand. Makes marking easier and keeps hands clean of paint. Perfect for out of reach areas.



Marking Pistol [No. 269]

Mark hazards, out-of-bounds lines & grounds repairs with a bright and vivid, fast drying solution. A hole-in-one for coverage, value, and performance!



Rust-Oleum Precision Line Marking Paint [No. 271]

Sold in cases of 12. Other colors are available upon request.

WE GO THE DISTANCE



590'-765' **RUST-OLEUM**

129'-222' **BRAND 1**

279'-442' **BRAND 2**

436'-530' **BRAND 3**

TRUSTED QUALITY SINCE 1921

RUST-OLEUM

INDUSTRIAL BRANDS

Rust-Oleum Precision Line marking paint for easy-to-read, bright, vivid markings with no mess. Marks more linear feet than other brands.



Aluminum Cup Setter
Part No. 205
Page 29

Lever Extraction Hole Cutter
Part No. 222
Page 28

1 Pronged Cup Puller
Part No. 210
Page 29

HOLE CUTTERS	28
CUP PULLERS	29
TRIMMERS	29
TOP NOTCH HOLE PAINT	29
WHITE PLASTIC CUP COLLAR	29
ALUMINUM CUPS	30
PLASTIC CUPS	30
ALUMINUM PRO-HOLE CUPS	31
CUP LINERS	31
CUP ACCESSORIES	32
REGULATION 1/2" POLES	34
REGULATION SMARTY STICKS	34
TOURNAMENT 3/4" POLES	35
TOURNAMENT SMARTY STICKS	35
REFLECTORS	36
FLAGPOLE RESTORATION	36
COURSE FLAGS	38
SPECIALTY FLAGS	38
FLAG ACCESSORIES	38
CUSTOM FLAGS	41
RAKE HEADS	42
RAKE HANDLES	42
COMPLETE RAKES	42
COCO DRAG MAT	43
GREENS TOOLS	43
BALL MARK REPAIR TOOL	43

HOLE CUTTERS

The hole cutters are primarily made of aluminum alloy, making them durable and strong but light. They each come with either scalloped or straight blade.



Lever Style Hole Cutter

Scalloped [No. 222] Straight [No. 223]
Easy to use lever for a quick hole extraction.



Lever Style Hole Cutter

Straight [No. 224] Scalloped [No. 225]
A classic hole cutter with shoe platforms on either side and a fixated handle.

Wider hole cutter that cuts a 6" wide hole. Perfect for the Temporary Cup No. 256



Wide Hole Cutter [No. 219]

A hole cutter for 6" wide temporary cup for special events.

REPLACEMENT BLADES

Heat treated cutting blades ensure a clean cut hole. Available as scalloped and straight blade with an inside edge (for sandy and USGA soil) or an outside edge (for push-up greens and native soil).



1. Inside Edge Scalloped Blade [No. 220-IN]
2. Outside Edge Scalloped Blade [No. 220-OUT]



3. Inside Edge Straight Blade [No. 221-IN]
4. Outside Edge Straight Blade [No. 221-OUT]



HOLE CUTTER ACCESSORIES

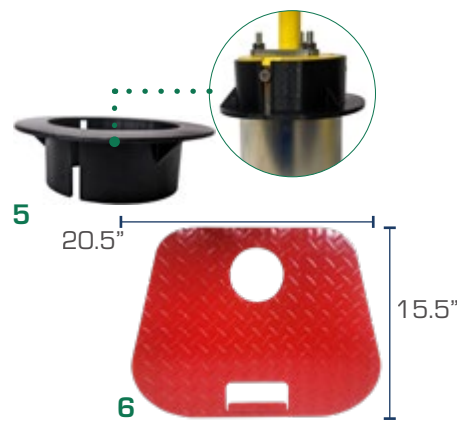

5. Hole Cutter Flanged Stop [No. 217]

Adjustable flanged stop ensures proper hole depth every time.

6. Red Hole Cutter Guide [No. 230]

Cast aluminum and powder coated, prevents scuffs and marks on the greens by the operator.



Top Notch Disc [No. 373]



Top Notch Paint Tool [No. 372]

TOP NOTCH HOLE PAINT

Brand new for 2024, Bayco Golf's new hole painting system, Top Notch.

It is faster, easier, and more convenient to use. The bigger can allows you to paint more holes than the competitors, up to approximately 150 holes per can of paint. The tool stays attached to the can, and with a simple push of the can on the paint disc (in the hole) it will paint in all directions reducing in overspray.

Each case includes 6 - 20oz cans, 1 paint tool and 1 disc.

Top Notch Hole Paint [No. 371WH-06]

Case of paint, tool, and disc [No.371WH-06]

Top Notch Paint Tool [No. 372]

Top Notch Disc [No. 373]

CUP PULLERS

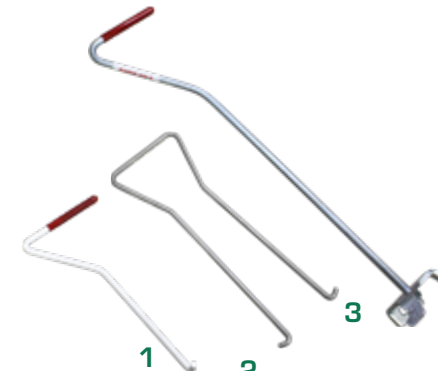

1. Single Prong Cup Puller [No 210]

Powder coated white with a red rubber handle for comfort. Size: approx. 6" Works on all cups.

2. Double Prong Cup Puller [No. 206]

Made of durable aluminum; Pinch and release, then pull out the cup. Size: approx. 8" Works on all cups.

3. Three Prong Cup Puller [No. 200]

Zinc plated steel with a red rubber handle; Place, twist and pull to remove the cup. Size: approx. 24" Works only on 250AL cups.

TRIMMERS

Superior quality scissors, constructed from forged Stainless Steel. Comes complete with a dedicated plastic carry wallet. The curved design makes it easier to neaten the edges of freshly cut holes.



Curved Trimming Scissors [No. 211]

WHITE PLASTIC CUP COLLAR

A white plastic cup ring makes the hole more visible and gives the same effect as hole paint without the labor and clean up. Easy to install and keeps integrity of cup when changing holes daily. This also stabilizes soil around the top of the hole which prevents erosion.



White Plastic Cup Collar [No. 251]

Individual [No. 251]

10 Pack [No. 251-10]

20 Pack [No. 251-20]



Hole-In-White Paint Applicator [No. 207]

Paint a perfect 1" depth circle above the cup while protecting the cup and grass around the hole, leaving a crisp, sharp edge.

No cup protector required.

ALUMINUM CUPS

These cups are die cast oversize, then machined down to precise dimensions to minimize wobble in the hole. The aluminum cups are anodized then powder coated a bright white for best corrosion protection. Meets all USGA requirements.



Aluminum Greens Cup (4.25"x4.25")
[No. 252AL]

Aluminum Green Cup (6"x4.25")
[No. 250AL]

Temporary Aluminum Greens Cup
[No. 256]

6" deep and 6" wide temporary cup for winter and special events.

PLASTIC CUPS

Made of durable, chemical resistant polymer material and meets all USGA regulations.



Plastic Greens Cup (4.25"x4.25")
[No. 255 PL]

Plastic Greens Cup (6"x4.25")
[No. 250PL]

Plastic Cup with Bronze Insert
(6"x4.25") [No. 250PL/BZ]

Bronze bushing made of certified bearing bronze withstands abrasion and prevents sticking, extending the life of your cup.

ALUMINUM PRO-HOLE CUPS

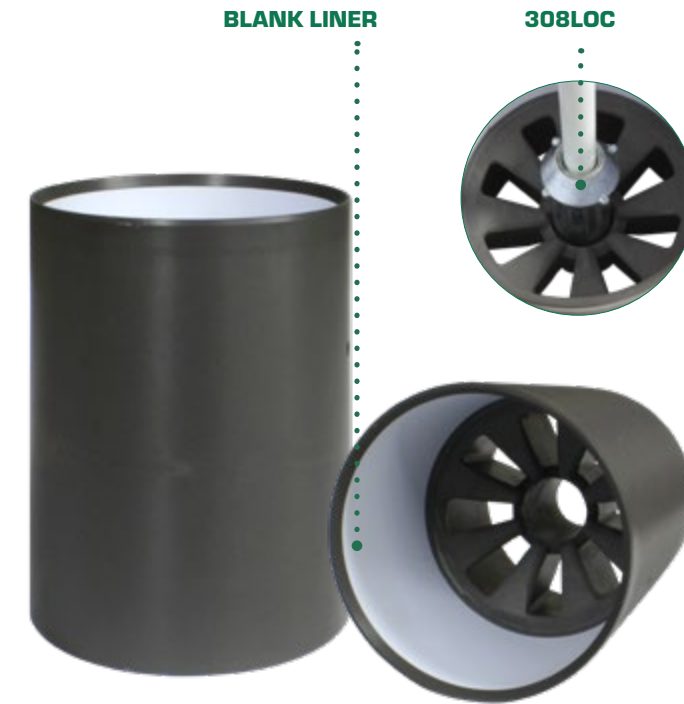

Pro Hole Cups are designed and finished to precise measurements, resulting in a world class greens cup. Completed with locking ferrule system that ensures unnecessary premature wear of the flag pole ferrule. Blank liner is included.

Aluminum Pro Hole Cup [No. 253AL-3]

This cup is made of durable heat treated aluminum alloy. Accepts British/locking [308LOC] ferrule to complete locking mechanism [pg. 34/35].

CUP LINERS

SpeedWrap liners are thin, flat inserts that fit only in our pro hole cups. Fully customizable with a club logo or sponsor for increased revenue. The blank and specialized cup liners are in stock and ready for immediate shipping.

SpeedWrap Liners [No. 253]

Blank Cup Liner [No. 253L-4 or 253L-3]
Customize Your Liner [No. 253CUSTOM]
(Minimum order of 20)
Sold in two versions. Please contact us for custom liners and version inquiries.

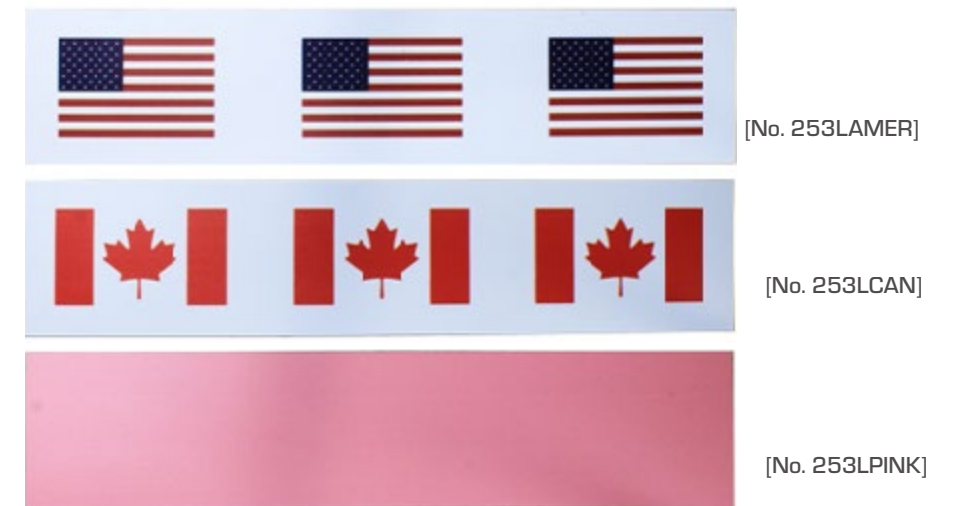

CUP ACCESSORIES



Cast aluminum cup setter consistently places cups at the correct depth, minimizing damage to the rims of aluminum cups and preventing ball interference.

Aluminum Cup Setter [No. 205]



Cover the putting green holes with this easy to install and remove cover. Made of durable plastic, it withstands pressure and weight.

Green Plastic Cup Cover [No. 262GR]



Cup sleeves are used in the installation of artificial putting greens. Made from PVC plastic and machined for a perfect fit! The cup will sit 1/8" above the plastic when installed.

Cup Sleeves [No. 259]

For 6" Cup (Plastic or Aluminum)
[No. 259-6]

For 4" Cup (Plastic or Aluminum)
[No. 259-4]



The perfect solution to stabilize a golf cup and keep it from pulling out of the hole. These 5x5" square, dense plastic plates with a grooved slot fit all of our plastic and aluminum cups (4.25" or 6" height). Add super Glue (not included) in the groove and press bottom of the cup into the slot and let dry.

Golf Cup Stabilizer [No. 263]













REGULATION 1/2" FIBERGLASS POLES

Our fiberglass poles are manufactured to the highest quality and appearance for excellent corrosion and weather ability. They are veil wrapped to increase lifespan and reduce splinters from fiberglass material.

- Top threaded bushing
- Color impregnated - color does not peel or fade with time
- Complete with a smooth ferrule and an acorn nut (other ferrules available)
- Suits the swivel of a grommet and tube style flags
- Ships with a sleeve on the bushing and ferrule for additional protection

Available Colors and Striping

	5'	7'	7.5'	8'
	300W-5	300W-7	300W-75	300W-8
	300Y-5	300Y-7	300Y-75	300Y-8
	--	300BW-71	300BW-751	300BW-81
	--	300YB-71	300YB-751	300YB-81
	--	--	300BW-752	--
	--	--	300YB-752	--
	--	--	300RW-752	--
	--	--	300BLW-752	--
	--	--	300PW-752	--
	--	--	300GW-752	--

**All other poles discontinued. Please see our website for available clearance stock on flagpoles.



Smooth Ferrule [No. 308SMO]



Slotted Ferrule [No. 308SLO]



Locking Ferrule [No. 308LOC]
Fits only our pro-hole cups [253AL].



REGULATION SMARTY STICKS

Six eye prism flag sticks bring 100% reflection coverage making those poles hotter, faster, and more accurate for all range finders. The prism reflectors are integrated into the pole itself. Length: 7.5'
Other colors and striping is available.









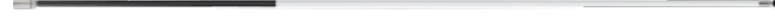

Item #	Description
SS300W-75	Solid White
SS300Y-75	Solid Yellow
SS300BW-752	White with Two Black Stripes
SS300BY-752	Yellow with Two Black Stripes
SS300RW-752	White with Two Red Stripes
SS300BLW-752	White with Two Blue Stripes
SS300PW-752	White with Two Pink Stripes
SS300GW-752	White with Two Green Stripes

TAPERED TOURNAMENT 3/4" FIBERGLASS POLES

Our fiberglass poles are manufactured to the highest quality and appearance for excellent corrosion and weather ability. They are veil wrapped to increase lifespan and reduce splinters from fiberglass material.

- Top threaded bushing
- Color impregnated - color does not peel or fade with time
- Complete with a smooth ferrule and an acorn nut (other ferrules available)
- Suits the swivel of a grommet and tube style flags
- Ships with a sleeve on the bushing and ferrule for additional protection

Available Colors and Striping

	7'	7.5'	8'	10'
	300TW-7	300TW-75	300TW-8	300TW-10
	300TY-7	300TY-75	300TY-8	300TY-10
	300TBW-71	300TBW-751	300TBW-81	--
	300TBY-71	300TBY-751	300TBY-81	--
	--	300TBW-752	--	--
	--	300TBY-752	--	--
	--	300TRW-752	--	--
	--	300TBLW-752	--	--
	--	300TPW-752	--	--
	--	300TGW-752	--	--

**All other poles discontinued. Please see our website for available clearance stock on flagpoles.



Smooth Ferrule [No. 308SMO]



Slotted Ferrule [No. 308SLO]



Locking Ferrule [No. 308LOC]
Fits only our pro-hole cups [253AL].



TOURNAMENT POLE JOINER

This is for 10 FT tournament poles only

Your 10 FT pole will come with the joiner already attached to one half of the pole, J-B Weld epoxy glue and instructions. Assembly required upon arrival. This is done to save on shipping costs.

TOURNAMENT SMARTY STICKS



Tournament Smarty Sticks [No. SS300T]

Six eye prism flag sticks bring 100% reflection coverage making those poles hotter, faster, and more accurate for all range finders. The prism reflectors are integrated into the pole itself. Length: 7.5'
Other colors and striping is available.

Item #	Description
SS300TW-75	Solid White
SS300TY-75	Solid Yellow
SS300TBW-752	White with Two Black Stripes
SS300TBY-752	Yellow with Two Black Stripes
SS300TRW-752	White with Two Red Stripes
SS300TBLW-752	White with Two Blue Stripes
SS300TPW-752	White with Two Pink Stripes
SS300TGW-752	White with Two Green Stripes

REFLECTORS

Easy to screw on top of any flag stick. Made with brass bushing to avoid premature wear of the threads. Sold individually.



Smarty Reflector - Six Eyed [No. 304-6BK]

Easy to screw on top of any flag stick. Made of specially formulated, soft polyurethane cylinder protects greens from flag swivel denting when dropped. Sold individually.



Elite Laser Reflector [No. 303-ELITE]

FLAGPOLE RESTORATION

An economical and easy way to re-new and protect splintered, cracked, faded, scratched, or dirty poles. Quickly applies with heat gun and will last for years. Fits tournament and regulation poles.



Bayco Guard for Flag Poles
250' Roll for 1/2" Pole [No. 3112]
250' Roll for 3/4" Pole [No. 3134]

Full 360° visibility, no dead spots, made of highly reflective material with a large surface area. Made for both 1/2" and 3/4" poles. Sold individually or in sets of 9.



Bayco Laser Reflectors
1/2" Opening [No. 3012]
Set of 9 [No. 3012-9]
1/4" Opening [No. 3034]
Set of 9 [No. 3034-9]

Make your own laser reflectors! Easy to install on your existing flag poles by heat shrinking the plastic provided on top of the reflector. It fits any pole of 1" or less in diameter. Sold only in sets of 9.



DIY Laser Reflector [No. 3000-9]

An easy to install ball lifter. Reduces bending and golfer-pole interaction. No need to remove the ferrule upon installation. 360° ball entrance with no interference. Fits regulation (1/2") and tournament (3/4") poles. All necessary hardware included.



Mully Cup Lifter [No. 319-01]

FLAGPOLE HOLDERS

Kit includes a holder, a Canadian or American 14x20" Regulation flag; an acorn nut and top bushing; and a 3' white regulation pole. No ferrule required. Flag pole holder mounts directly to your choice of surface (wall, ground or other).



Flag Pole Holder Kit - American [No. 345AMER]



Flag Pole Holder Kit - Canadian [No. 345CAN]

Flag pole holder mounts directly to your choice of surface. Holds 1/2" poles only.

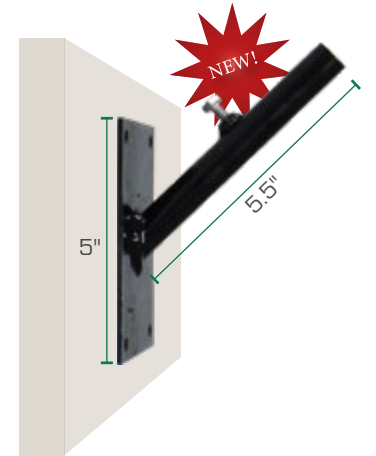

Flag Pole Holder Only [No. 345]

Our Universal Flag Holder allows you to attach a flag to virtually any cart. It features a 2' white pole and either a 6x8" (DS) or 14x20" (SS) handicap flag.



Universal Flag Holder with Flag
6x8" Handicap Flag [No. 346HDGP-1]
14x20" Handicap Flag [No. 346HDGP-2]
6X8" Canadian Flag [No. 346CAN]
6X8" American Flag [346AMER]

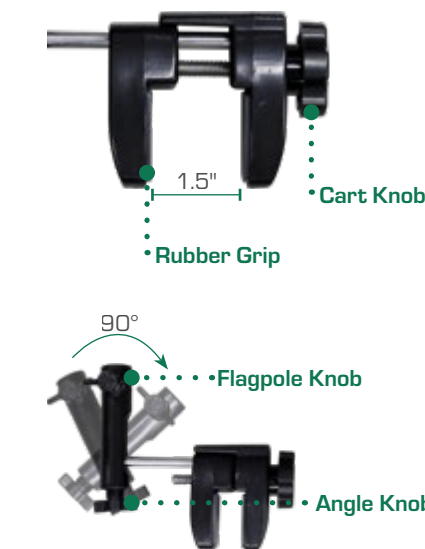

Other flags can be attached, as well.

Would you like a different pole or flag? Purchase the holder only and/or the rod only separately. Please contact us for more information.



1. Rod Only [No. 346ROD]
2. Universal Holder Only [No. 346]

COURSE FLAGS

All of our course flags are made of durable, quality, 400 Denier Solar Max material* complete with a tube locking attachment.

*Custom colors available.

- Red
- Yellow
- Emerald Green
- Pink
- White
- Orange
- Light Blue
- Hunter Green
- Royal Blue
- Purple
- Brown
- Black



14x20" Nylon Solid Color Tube Flag [No. 1005T]

FLAG ACCESSORIES



1. Quick Click [No. 316PL]

Removes the need for tools to change the flags. Works only with Bayco Tube Flags. Available as set of 9 [No. 316PL-9]

2. Security Nut [No. 1005NUT]

Secures flags onto flag poles and prevents theft. Slim enough to be used with or without the Acorn Nut.

3. Acorn Nut [No. 1005-3BK]

SPECIALTY FLAGS

Made of double sided Poplin material and dye sublimated for added durability, making them less vulnerable to fading and eliminating peeling. They come complete with a tube locking attachment.



14x20" American Flag [No. 1005AMERT]



14x20" Canadian Flag [No. 1005CANT]



14x20" Marshall Flag [No. 1005MART]

NUMBERED FLAGS

Our numbered flags are made of Dura material and are dye sublimated*. Complete with a tube locking attachment.

*Custom colors available.

- White/Black #'s
- Green/White #'s
- Red/Black #'s
- Black/White #'s
- Yellow/Black #'s
- Blue/White #'s
- Red/White #'s



14x20" Numbered Tube Flag [No. 1007T]

Sold only in sets of 1-9 or 10-18.

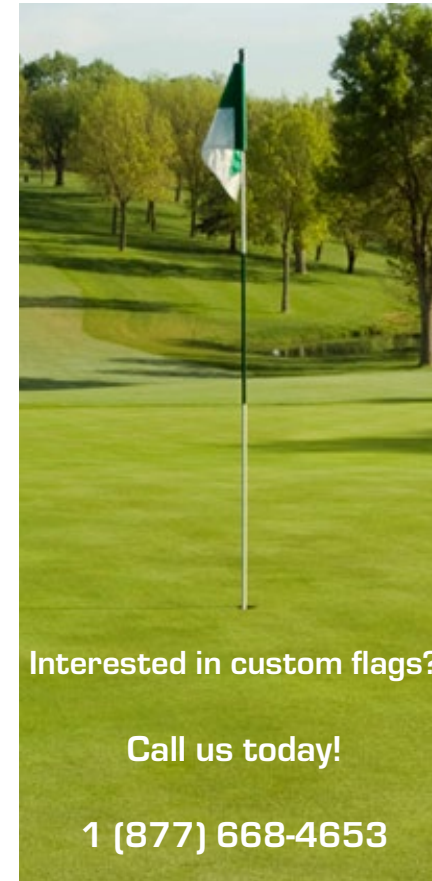

Interested in custom flags?

Call us today!

1 (877) 668-4653

STOCKED SPECIAL EVENT FLAGS

Our special event flags are made of double sided Poplin material and are dye sublimated. Come complete with a tube lock attachment.



14x20" Awareness Flag [No. 1005BCAT]

14x20" Revenge Flag [No. 1005REVT]

CHECKERED FLAGS

Our checkered flags are made of Dura material and are dye sublimated*. Complete with a tube locking attachment.

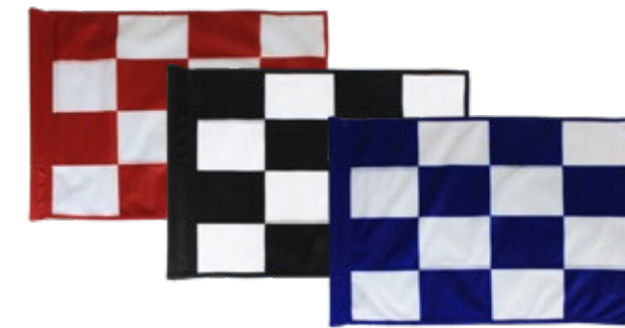

14x20" Checkered Tube Flag [No. 1005CHT]

- White/White
- Blue/White
- Red/White
- Green/White
- Yellow/White
- Black/White
- Black/White

*Custom colors available.

ANY COLOR COMBINATION

If you can think it, we can print it! We can help you choose the colors that compliment your logo best, or if you already have a color in mind and/or know the color code (HEX, RGB, CYMK) we can match it. We can even change the colors of your logo!*

ANY LAYOUT

Whether you need a border or not, numbers or text, or simply your logo** on the flags - we can do it! If you have a custom graphic that you want displayed on your flag, or you'd like to show off your sponsors - we are here for you! If you have a new feature and would like to advertise or you want to honor someone special - it's all possible with Bayco Custom Golf Flags!

UNLIMITED CHOICE - ONE PRICE

We offer several different sizes of custom golf flags, of which 14"x20" and 6"x8" are most common. We also provide three different shapes - rectangle, burgee, and pennant. You can order them double sided (DS) or single sided (SS). Our prices for each flag type/size are the same no matter what colors or layout you choose. There are no set up fees for proofs and you can make changes until you are satisfied with the result! Don't be afraid to get creative, **your only limit is your imagination!**

*Logos must be high resolution and be either a PDF or a vector file (.ai or .eps)

** Any graphics or logos must be obtained legally and have all the required permissions to be used in your custom flag design. Bayco Golf is not responsible for any lawsuit related to the distribution of illegally obtained content.

CALL 1 (877) 668-4653 OR YOUR NEAREST BAYCO DISTRIBUTOR TO ORDER YOURS TODAY.

Possibilities are endless!

“SIMPLY - THE FINEST QUALITY CUSTOM GOLF COURSE FLAGS

Frequently Asked Questions:

WHAT IS DYE SUBLIMATION PRINTING?

Dye Sublimation is a printing process which reproduces graphics and images into various flexible and rigid substrates – in our case, fabric. Using a combination of high heat and pressure, solid dyes are absorbed directly into the fabric, creating many advantages over traditional screen-printed graphics.

HOW ARE OUR FLAGS MADE?

Once a design is approved, the graphic files are fitted onto a template using Illustrator. Those files are printed and then sublimated into the fabric. The fabric portion with dye is cut out and passed on to our sewing and finishing department. After finishing, the products are cleaned, checked and are packaged for shipping.

WHAT FORMAT SHOULD YOUR ARTWORK BE IN?

Please ensure that your artwork files are of good quality, preferably vector (.ai or .eps). Raster images, such as JPEG and PNG can be submitted but extra charges may apply should we need to re-draw them in a vector format. If you are unsure of what files you currently have, please contact us and we can assess them for you.

HOW LONG DOES IT TAKE FOR FLAGS TO BE COMPLETED?

Once we send you the proofs and they are approved by you, it typically takes 2-3 weeks for them to be printed (on a first come, first serve basis). Shipping (depending on location) can take additional 3-7 business days in North America. Please contact us for a more accurate timeline for your specific project.

WHAT FABRIC CHOICES DO YOU OFFER?

- **Poplin Flags** - Our poplin flags are great for heavy graphics and double sided flags because it uses an optional blocker to prevent see-through from front to back. **Note:** It is the heaviest option especially if the blocker is added. This fabric needs wind to move.
- **Dura Flags** - Very stable fabric that is porous and allows wind to move through it. It has 95% transparency which makes it perfect for single sided flags.
- **Poly Silk Flutter** - This fabric is recommended for events as it flutters even in low breeze settings. It has 98% transparency and is very lightweight, perfect for single sided flags.

HOW IS VECTOR DIFFERENT THAN RASTER?

Simply put, raster images are created by pixels and their quality depends on the DPI (dots per inch) or PPI (pixels per inch). The lower the DPI, the more "pixelated" it looks. Raster image files include .jpeg, .png, and .tiff formats.

Vector images are made up of paths with mathematical formulas telling the path what color or shape it needs to be. Thus, vector images retain their appearance regardless of size and can be scaled infinitely. Although vector files are rarely used for photographs or paintings, they are perfect for designs such as logos and illustrations. Vector files include .ai, .eps, and .dwg formats.



RAKE HEADS

Our rake heads are made of durable, lightweight plastic that is easy to use and carry. They spread sand evenly, leaving a consistent playing surface with minimal difference in grooves.



Lightweight Rake Head
21" [No. 102BK]; 15" [No. 105BK]



Octagon Rake Head
24" [No. 164BK]; 15" [No. 151BK]



Disc Tooth Rake Head
Available only in 16" [No. 161BK]

RAKE HANDLES



Yellow Wooden Handle
Available only in 48" [No. 106YE-48]



Green Fiberglass Handle
51" [No. 152GR-51]
72" [No. 152GR-72]



Yellow Fiberglass Handle
51" [No. 152YE-51]
72" [No. 152YE-72]



Brown Fiberglass Handle
Available in 51" [No. 154BR-51]
Available in 72" [No. 152BR-72]

BACK IN STOCK



Green Cart Fiberglass Handle*
42" [No. 155]
51" [No. 152GR-CART]

* Other colors and sizes available upon request.



Armored Rake Handle
51" [No. 154-1B]

* Better grip, prevents splintering

BAYCO SHRINK GUARD FOR RAKE HANDLES

No more fiberglass slivers from your rake handles. An economical and easy way to re-new your rakes and protect splintered, cracked, faded, scratched, dirty fiberglass handles. Quickly applies with heat gun and will last for years.



125' Roll | 140BK-125
250' Roll | 140BK-250



125' Roll | 140GR-125
250' Roll | 140GR-250



125' Roll | 140YE-125
250' Roll | 140YE-250

COMPLETE RAKES

Lightweight Rake	15" Head	21" Head
48" Wooden Handle	100PO	125YE
51" Green FG Handle	118GR	125GR
51" Yellow FG Handle	118YE	126YE

Octagon Rake	15" Head	24" Head
51" Green FG Handle	150GR	166GR
51" Yellow FG Handle	150YE	166YE
72" Green FG Handle	150-72G	165GR
72" Yellow FG Handle	150YE/72	165YE
42" Green Cart Handle	150GR/CART	166YE

Disc Tooth Rake	16" Head
51" Green FG Handle	160GR
51" Yellow FG Handle	160YE
72" Green FG Handle	160GR/72
72" Yellow FG Handle	160YE/72
42" Green Cart Handle	160GR/CART

COCO DRAG MAT

Made of natural fiber that will not damage, burn, or bruise tender grass. The fibers offer superb broom action, making it perfect for top dressing and filling aerated holes. Complete with a tow bar and a chain for easy attachment.

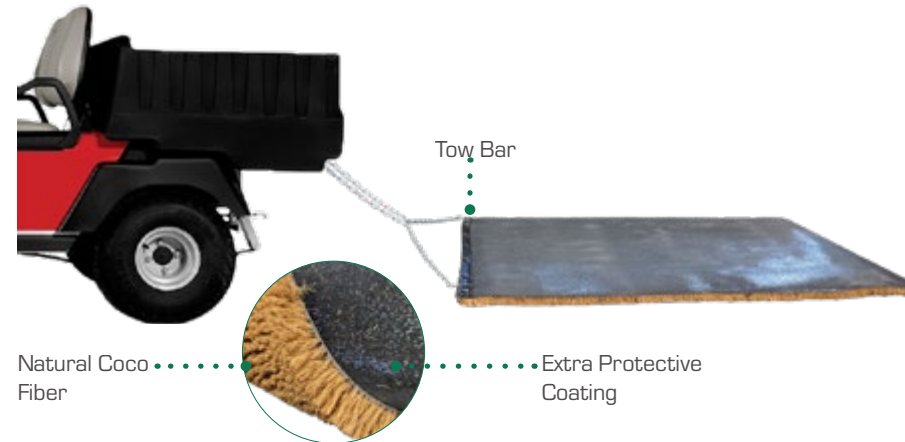

Natural Coco Fiber Extra Protective Coating

Bayco Golf Coco Drag Mat

6' x 4' Coco Mat [No. 247-6x4]

Topdressing keeps the greens healthy by breaking up organic matter and allowing more decomposition.

BALL MARK REPAIR TOOL

New and improved ball mark repair tool. No moving parts, one solid piece of aluminum with six blades forces grass and roots into damaged areas. Cap included. Length: 36"

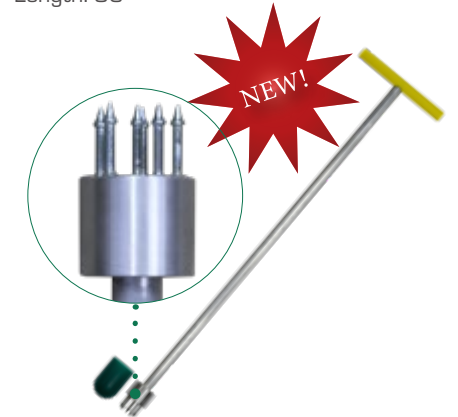

InstaFix Repair Tool [No. 227-36]

GREENS TOOLS

Removes dew and other light debris from greens. The tip (8") slides inside the handle (8") during storage and transportation.



Dew Whipping Pole

Complete Unit [No. 280]
Replacement Rod [No. 280-2A]

Made of extruded aluminum alloy with a V-shaped groove extending along its length and a milled base to reduce bounce as the ball makes contact with the green surface. Length: 36"

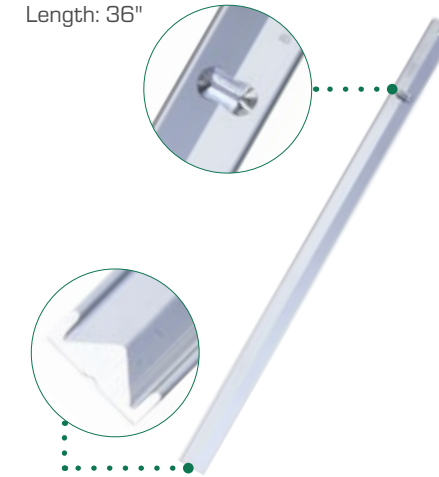

Bayco Golf Greens Speedmeter [No. 240]





CAST IN MOLD CUSTOM SIGNAGE	46
RECYCLED PLASTIC CUSTOM SIGNAGE	48
CAST IN MOLD GROUND TEE MARKERS	49
RECYCLED PLASTIC EASELS	49
ACP CUSTOM SIGNAGE	50
HEAVY DUTY SIGNAGE	52
ALUMINUM & DIRECTIONAL SIGNAGE	53

CAST IN MOLD BRONZE AND ALUMINUM CUSTOM SIGNAGE

Our premium bronze and aluminum signage help identify each hole while bringing elegance to the course and adding to the golfer's experience.

STEP 1: Choose your shape
We offer 10 classic shapes for your sign.



STEP 2: Choose your style
We offer three different styles to showcase information about your course.

All you need to provide us with is your course logo and hole information!

Note: If you choose Imperial, we would require artwork for the course holes, also.



SIGNATURE

- Course Logo
- Hole Number
- Par Number

CLASSIC

- Course Logo
- Hole Number
- Par Number
- Tee Box Yardages
- Colored Dots (optional)

IMPERIAL

- Course Logo
- Hole Number
- Par Number
- Tee Box Yardages
- Colored Dots (optional)
- Hand-Painted Hole Map

STEP 3: Choose your size
Use the size chart to the right for the best size for the desired style.

SIZE	SIGNATURE	CLASSIC	IMPERIAL
10"x16"	✓		
12"x14"	✓		
12"x18"	✓	✓	
14"x20"	✓	✓	✓
14"x22"		✓	✓
16"x22"		✓	✓
18"x24"			✓

STEP 4: Customize your signage with finishing touches on the next page.

SIGNAGE CUSTOMIZATION OPTIONS

CAP OPTIONS



MOUNTING OPTIONS

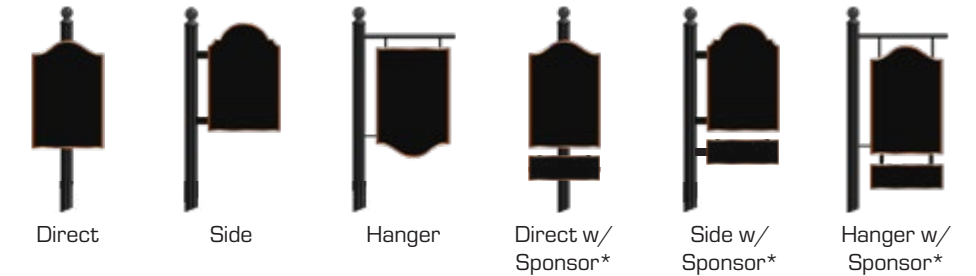

*More than one sponsor can be added.

PIPE OPTIONS



Posts are typically 3" but they are available in 4", as well.

POST BASE OPTIONS



Post bases can be mounted to a surface or they can come with an 24" extension pipe for direct burial.



With recycled plastic signs the possibilities are virtually endless. It is a superior, yet an economical, way to add first class signage to your facility.

STEP 1: Choose your shape from the ones shown or send us your idea.

RECYCLED PLASTIC CUSTOM SIGNAGE



STEP 2: Select the style and size. You can also choose between no border, single border, or double border.



We can fill the yardage dots with our durable resin!



SIGNATURE

- Course Logo
- Hole Number
- Par Number



CLASSIC

- Course Logo
- Hole Number
- Par Number
- Tee Box Yardages
- Colored Dots (optional)



IMPERIAL

- Course Logo
- Hole Number
- Par Number
- Tee Box Yardages
- Colored Dots (optional)
- Hand-Painted Hole Map

*Other sizes available.

SIZES*

- 15"x19"
- 18"x24"
- 24"x30"

STEP 3: Choose the color combination.

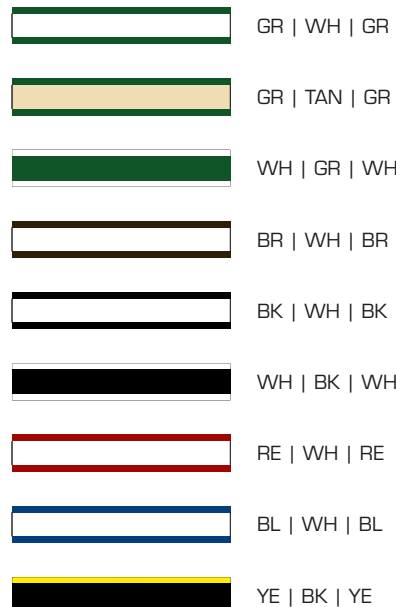

STEP 4: Select your logo style.

The **inset method**, your design is reverse printed onto a protective shield, then embedded into the sign and sealed with clear resin.



The **engraved method** allows for the design to be 'sunk' into the base. Your design is precisely engraved into the sign base, leaving it blank. You may choose to have it filled with our special resin.



In-ground yardage markers properly mark the course which speeds up the pace of play. They come complete with two spikes to keep them in place. Available in bronze or aluminum.

CAST IN MOLD BRONZE AND ALUMINUM GROUND TEE MARKERS

Display your brands/logos or sponsors across the facility. These signs leave a long lasting impression. All you need to provide us with is the artwork of your chosen logo/sponsor and we will do the rest.

Can't find what you're looking for? We can customize your project further! Call to inquire today!

STEP 1: Choose your shape.

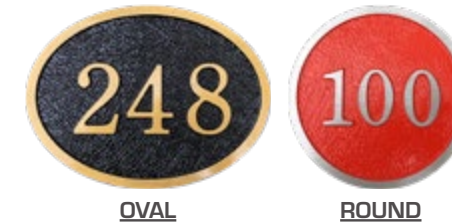

OVAL

ROUND



RECTANGLE

SQUARE

STEP 2: Choose your size.

SIZE
5"x3"
6"x4"
7"x5"
8"x6"
9"x7"
10"x7"
10"x8"

SIZE
5"x5"
6"x6"
7"x7"
8"x8"
10"x10"
12"x12"

STEP 3: Choose your border.



NO BORDER

BORDER



BROKEN BORDER

BEVELED BORDER

RECYCLED PLASTIC EASELS

Made from 1/2" recycled plastic material with resin filled flags. Easily display important information for your golfers such as the golf time or the daily yardage. Available as single or double sided. The design features an aluminum hinge mount for easy transportation, storage, and assembly.

SIZE	CLOCK	YARDAGE
16"x24"	✓	✓
22"x32"		✓



ACP CUSTOM SIGNAGE



SIGNATURE

- Course Logo
- Hole Number
- Par Number



CLASSIC

- Course Logo
- Hole Number
- Par Number
- Tee Box Yardages
- Colored Dots (optional)



IMPERIAL

- Course Logo
- Hole Number
- Par Number
- Tee Box Yardages
- Colored Dots (optional)
- Hole Map

This sign is made out of aluminum composite panel (ACP) material that is comprised of two .30mm aluminum sheets and bonded to a solid polyethylene core. The design is printed on to the material and then sealed with a clear coat.

Your options are unlimited with our new line of signs, they can be customized to your liking. Choose from different colors and border styles!

Black aluminum sign post available - inquire for more information.

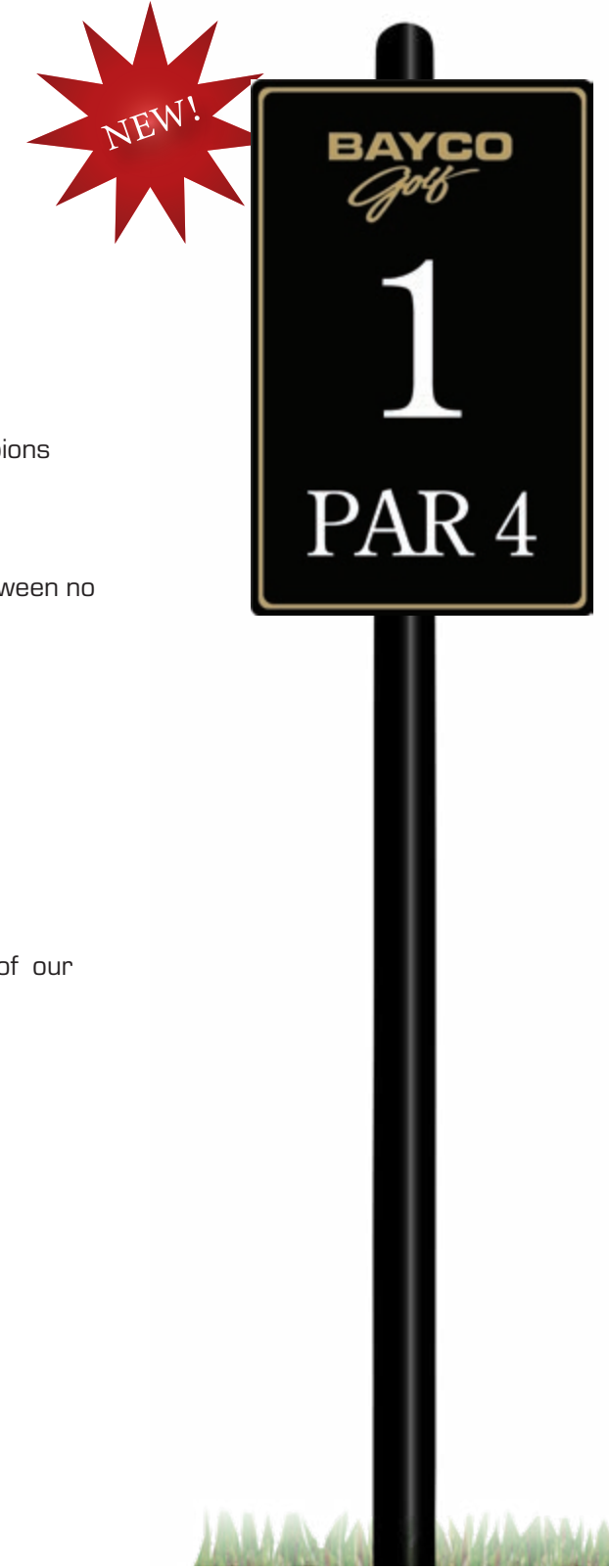

STEP 1:

Choose the color combination of your sign, the options are unlimited. Inquire for more information.

STEP 2:

Select the style and size. You can also choose between no border, single border, or double border.

Sizes:
15"x19"
18"x24"
24"x30"

Custom Sizes Available

STEP 3:

CHOOSE DESIGN OF SIGN LAYOUT

Your choices are endless! We can create almost anything you can think of, either choose from one of our layout's or have it custom designed.

Artwork required for logos.

HEAVY DUTY SIGNAGE

Our Heavy Duty Metal Signs are produced from a single piece of 3mm metal with a powder coated finish. They come with single or double spikes and are available single or double sided. We have these signs with stock messages or we can design a custom message with your course logo. All messages are applied to signs using a pressure sensitive label, so the possibilities are virtually endless!



8"x6" Heavy Duty Steel Signs [No. 591]

Available stock messages:

Please Replace Divots
 Carts This Way →
 Carts This Way ←
 No Carts Beyond This Point
 Next Tee ←
 Next Tee →

[add -03]
 [add -06]
 [add -07]
 [add -08]
 [add -12]
 [add -13]

7"x12" Heavy Duty Steel Signs [No. 592]

Available stock messages (cont):

Keep carts off apron
 Keep carts 30 ft from greens
 Drop Area
 Please Repair Ball Marks

[add -14]
 [add -15]
 [add -17]
 [add -18]

*Simply add the extension number for the specific stock message. For example, "Drop Area" on an 8x6" would have an item number 591-17.

CUSTOMIZE YOUR OWN SIGN:

1. Choose your sign size (8x6" or 7x12")
2. Select single or double sided:
 - You may have the same message on both sides or different messages on either side.
3. Design your decal. As long as it fits on the sign, anything can be printed. Please contact us for more information.

Minimum order of 6.



ALUMINUM AND DIRECTIONAL SIGNAGE

Aluminum spikes come as one piece. Use with Aluminum Signs. Sold separately.

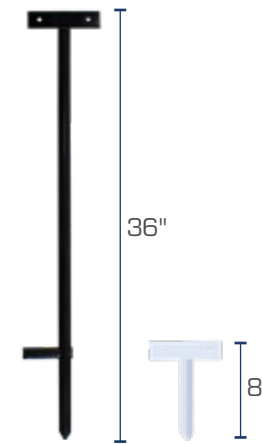

Aluminum Spikes for Customizable Signs

Color	36" Spike	8" Spike
Black	529	500-1BK
White	529W	500-1

Aluminum Signs are produced from a single piece of 3mm metal with a powder coat finish. **Minimum order of 6.**

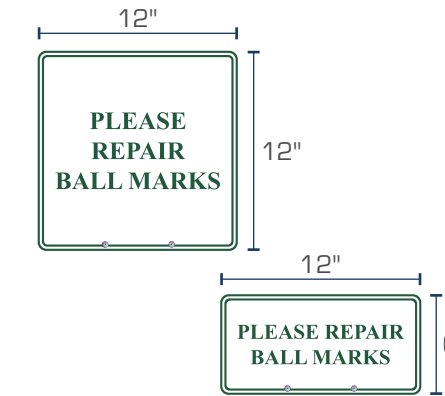

Customizable Aluminum Signs

Stock Message	12"x12"	6"x12"
No carts beyond here	500-10	528-10
Carts in rough only	500-11	528-11
Chemicals applied today	500-12	528-12
No Carts Today	500-13	528-13
Please repair ball marks	500-14	528-14
Ground under repair	500-15	528-15
Covid-19 rules	500-19	528-19

Custom lettering & numbering available
 Inquire for more details.

Made from high quality steel, with a powder coated finish and white lettering. One complete piece, eliminating the need for spikes. **Minimum order of 6.**

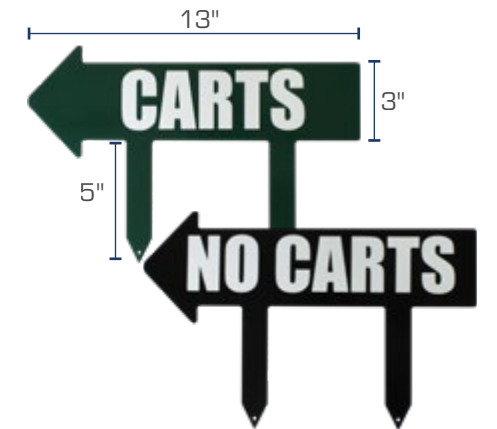

Two Sided Aluminum Directional Signs

Stock Message	Green	Black
Plain Arrow	540GR	540BK
Next Tee	541GR	541BK
Carts	542GR	542BK
Golf Carts	543GR	543BK
10 Tee	544GR	544BK
No Carts	545GR	545BK

Custom lettering & numbering available
 Inquire for more details.



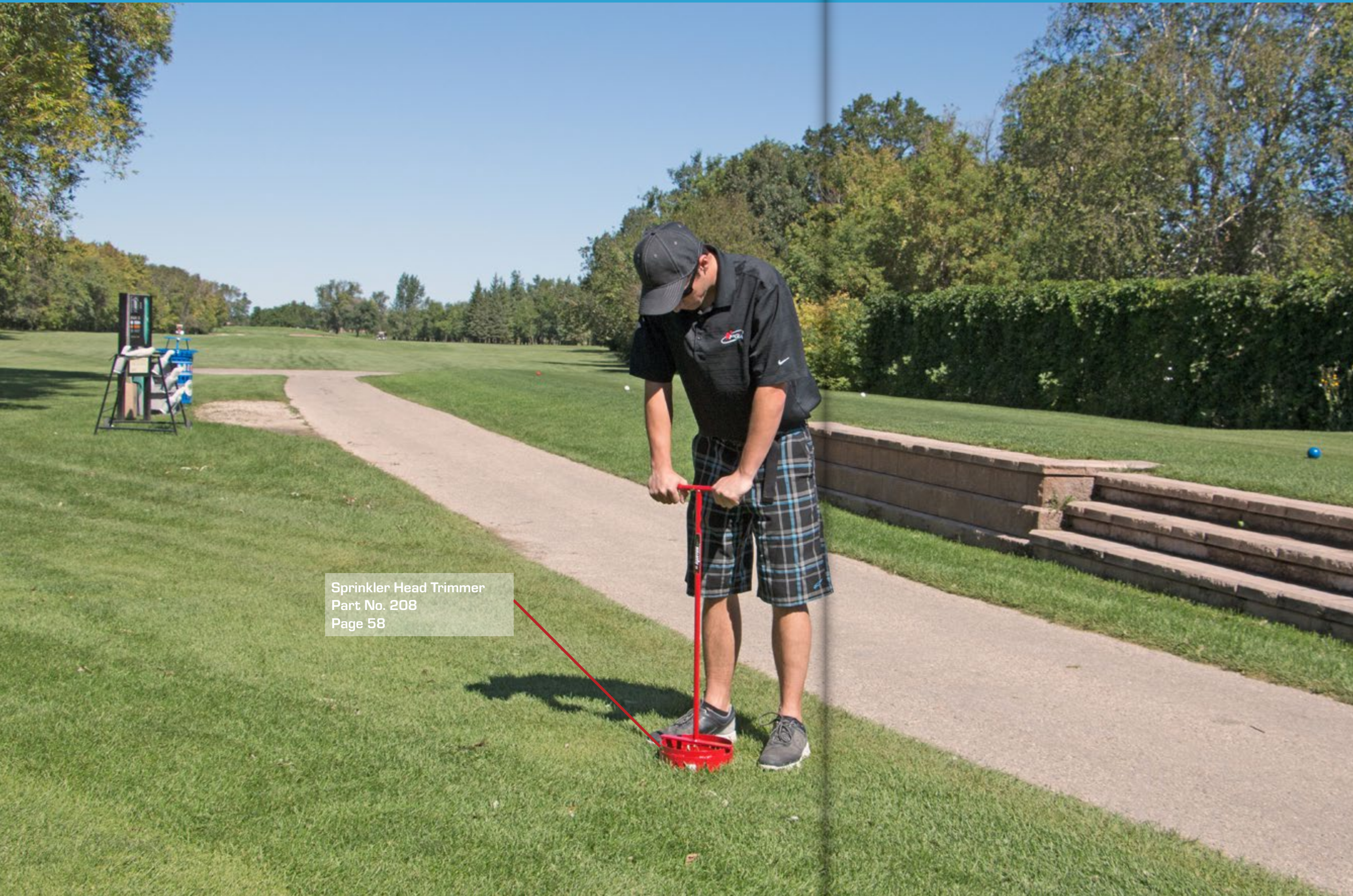

Sprinkler Head Trimmer
Part No. 208
Page 58

SOIL SAMPLERS	56
AERATORS	57
SPRINKLER HEAD TRIMMERS	58
LANDSCAPERS & SQUEEGEES	58
OTHER MAINTENANCE TOOLS	59

SOIL SAMPLERS

Soil samplers allow core samples to be taken for evaluation of soil composition and root growth or for subsequent soil analysis. It also helps determine the need for aeration and to select the proper fertilizer for root development.

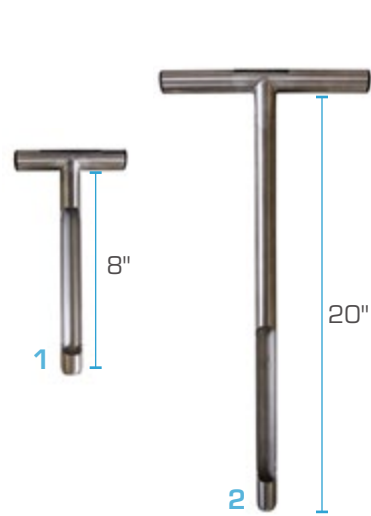

- 1. 8" Soil Sampler [No. 235-8]**
One piece rugged stainless steel pipe.
- 2. 20" Soil Sampler [No. 235]**
One piece rugged stainless steel pipe.

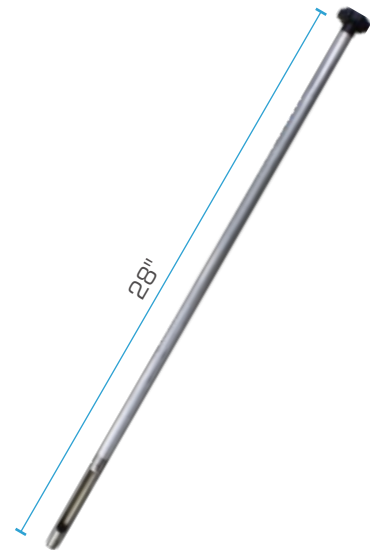

28" Greens Soil Sampler [No. 237]
Less intrusive, one piece rugged stainless steel pipe. Complete with a rubber handle for added comfort.



Greens Section Soil Sampler [No. 238]
This spade-like greens section soil sampler is tapered to give a clean cut and minimize surface disruption. The blade is then easily removed to examine the profile of the sample.



AERATORS

Made of heavy duty steel, these aerators are easy to use on those small and hard to reach spots on the greens that need immediate attention.



Three-Pronged Aerifier [No. 236]



Five-Pronged Aerifier [No. 239]

Fits our aerifiers. Sold in sets of three. Complete with holding pins.



Replacement Steel Tines [No. 236-1]

Why aeration is important?

Aeration is an essential practice that improves the long-term health and playability of golf courses. By using hollow tines to extract plugs, you can:

- Ensure longevity of your course
- Alleviate compaction
- Remove layering

Long lasting benefits of aeration:

The following benefits can be observed when aeration is done seasonally and correctly:

- Improves Water Infiltration
- Oxygenates The Soil
- Removes Thatch
- Encourages Root Growth
- Stimulates Microbial Activity
- Promotes Recovery From Stress

SPRINKLER HEAD TRIMMERS

Sprinkler heads can easily become lost on the course and lead to negative impacts on the functionality of the irrigation system. These trimmers are easy to use and leave a clean edge around the sprinklers.

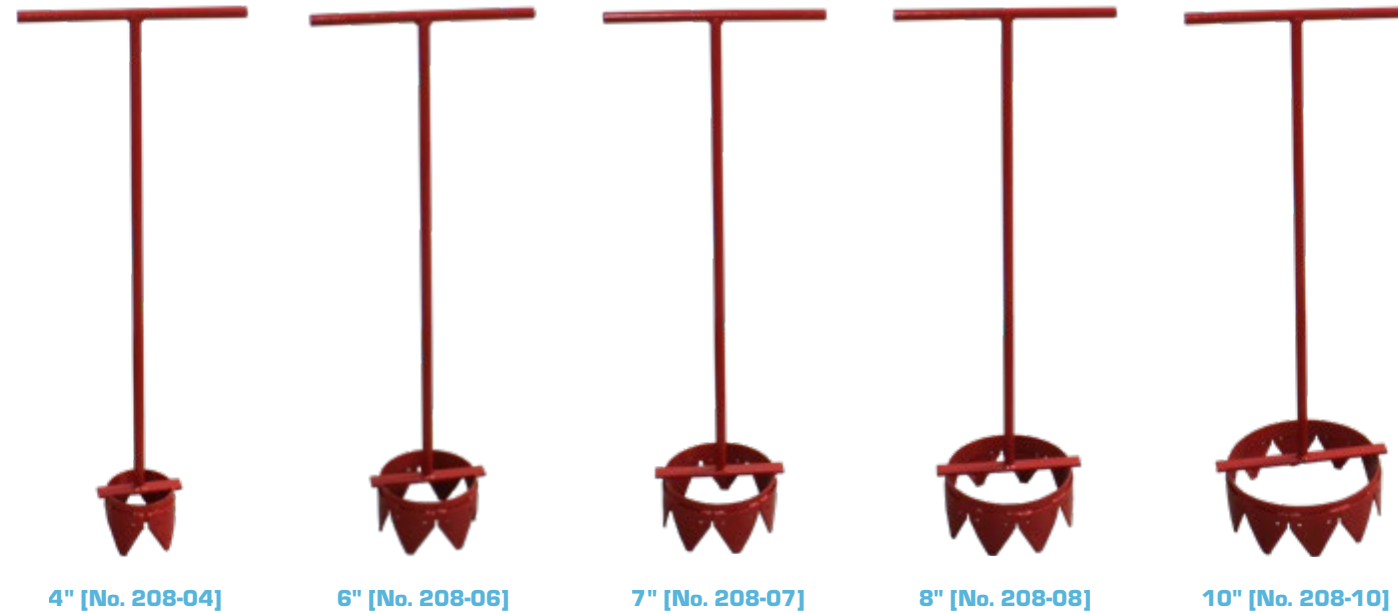

LANDSCAPERS AND SQUEEGEES

This aluminum landscape rake is used for ground raking, smoothing, leveling, spreading, seeding & leaf clean-up. The heavy duty brace is all one piece and is riveted to the rake head.

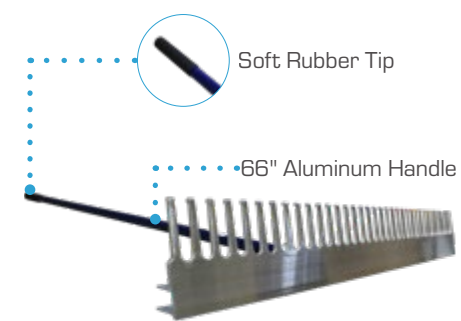

Aluminum Landscaper

Head Length	Stock Code
24"	114AL
36"	115AL
48"	116AL

A squeegee roller made of industrial grade stainless steel axle and efficient non-absorbent rubber roller; effectively rolls collected water. Replacement heads available while quantities last.

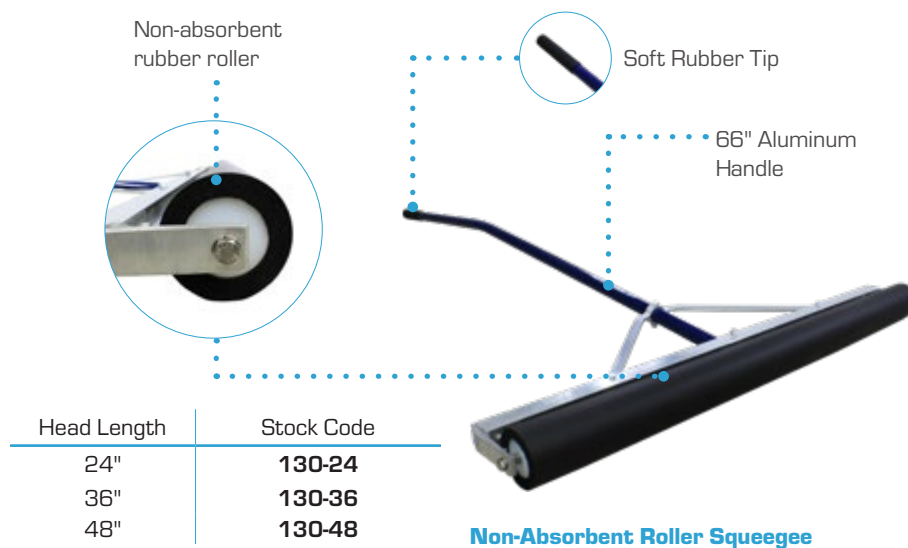

Head Length	Stock Code
24"	130-24
36"	130-36
48"	130-48

OTHER MAINTENANCE TOOLS

Light, heavy duty aluminum plug pusher will make cleaning up the golf course easy. It efficiently pushes plugs or moves and levels sand and loose material.

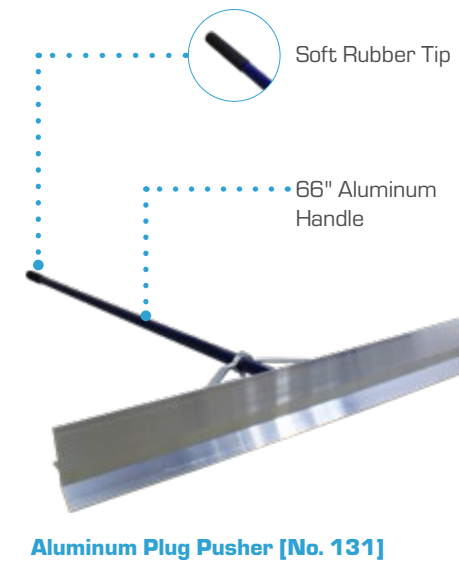

Durable, dense polyethylene tank, easy to fill 4.25" opening, 28" wand, and chemically resistant seal. Capable of performing every spraying task.



Aluminum shaft with stainless steel grabbers that open to a 4.5" width. Capable of lifting up to 6 lb and sensitive enough to pick up a dime.





Range Club Washer
Part No. 695
Page 64

Recycled Plastic Bench
Part No. EE1214
Page 15

Medium Divot Mix Container
Part No. 696
Page 10

Bungee Rope
Part No. 400YE
Page 24

PRACTICE GREENS MARKERS	62
PRACTICE GREENS POLES & BASES	62
PRACTICE GREENS FLAGS	63
RANGE FLAGS	63
RANGE CLUB WASHERS	64
CHIPPING GREENS BALL PUSHER	64
RANGE BANNERS	65

PRACTICE GREENS MARKERS

A 28" tall gimme marker with a 1/2" thick fiberglass rod and a cast aluminum head. The head can be customized with your own logo decal or a sponsor.

● Green ● Red ○ White



Gimme PG Markers w/ Plastic Base

Decal:	Plastic Base
Blank	264/BLANK
Set of 1-9	264/1-9
Set of 10-18	264/10-18

Gimme PG Markers w/ Chrome Base

Decal:	Chrome Base
Blank	264/BLANK/CH
Set of 1-9	264/1-9/CH
Set of 10-18	264/10-18/CH

PRACTICE GREENS POLES AND BASES

Made with fiberglass rod, the poles come with plastic, chrome or target base.

Javelin poles are tapered to 3/4" in the middle making them stronger.

Chromium on metal provides corrosion resistance and increases surface hardness. Plastic is a light and more economical alternative to the chrome base.



Practice Greens Flag Poles

Base:	White Rod	Yellow Rod
Chrome Base	272WH-CH	272YE-CH
Plastic Base	272WH	272WH
Target Base	272WS	272YS

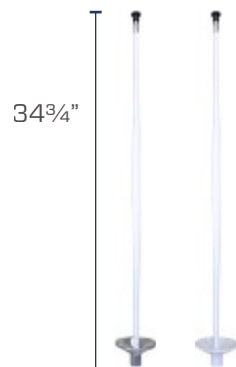

Javelin Practice Greens Poles

Base:	Javelin Rod
Chrome Base	272WH-J/CH
Plastic Base	272WH-J



Practice Chrome & Plastic Green Bases

Opening:	Chrome Base	Plastic Base
5/16"	278-2CH	P275-2
3/8"	278-6CH	P275-3
1/2"	278-7CH	P275-5

6X8" PRACTICE GREENS FLAGS

Made of durable 400 Denier Solar Max material complete with a tube locking attachment.

● Red ● White ● Blue
● Yellow ● Green ● Orange
● Black ● Purple ● Pink



6x8" Nylon Practice Greens Tube Flag [No. 273T]

*Custom colors available.

Made of double sided Dura material and dye sublimated for added durability. Complete with a tube locking attachment.

● Blue/White ● Red/White
● Black/White ● Black/Yellow
● Green/White

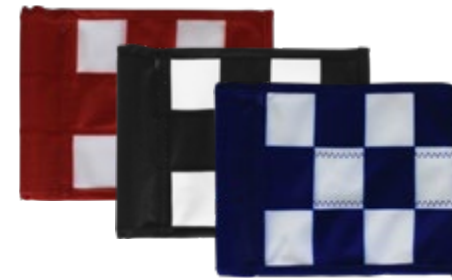

6x8" Checkered Practice Greens Tube Flag [No. 273CHT]

*Custom colors available.

Made of double sided Poplin material and dye sublimated for added durability. Complete with a tube locking attachment.

● White/Black #'s ● Yellow/Black #'s
● Blue/White #'s ● Red/Black #'s
● Red/White #'s ● Green/White #'s



6x8" Numbered Tube Flag [No. 273T]

Sold only in sets of 1-9 or 10-18.
*Custom colors available.

18X26" RANGE FLAGS

Made of double sided Poplin material and dye sublimated for added durability, making them less vulnerable to fading and eliminating peeling. Complete with a tube locking attachment.

Made of durable 400 Denier Solar Max material complete with a tube locking attachment.

Made of double sided Dura material and dye sublimated for added durability. Complete with a tube lock attachment.

● Blue ● Red ● Green ● Green/White ● Yellow/White
● Yellow ● White ● Light Blue ● Blue/White ● Black/Yellow
● Black ● Purple ● Navy Blue** ● Black/Red ● Red/White
● Pink ● Hunter Green ● Burgundy ● Black/White ● Orange/White
● Gold ● Orange ● Brown
*Custom colors available **WGL



6x8" Specialty Practice Greens Flags

American Flag [No. 273AMERT]
Canadian Flag [No. 273CANT]
Marshall Flags [No. 273MAR]



18x26" Nylon Range Flags [No. 1009]



18x26" Checkered Range Flags [No. 1008CHT]

*Custom colors available

PRACTICE AND RANGE

RANGE CLUB WASHERS

Heavy-duty polyethylene body & cover. Holds two 12" x 12" bristle brushes that can be rotated for maximum utilization. Handles on either side for lifting & moving. Cover has 6" opening for easy access. No wires, clamps or screws required. Will not lift during use.



Black Range Club Washer [No. 695BK]

Green Range Club Washer [No. 695GR]

12" x 12" replacement brush for 695 Range Club Washer. Perfectly symmetrical on all sides allows for rotation and maximum utilization. Sold individually. Each club washer requires 2 brushes.

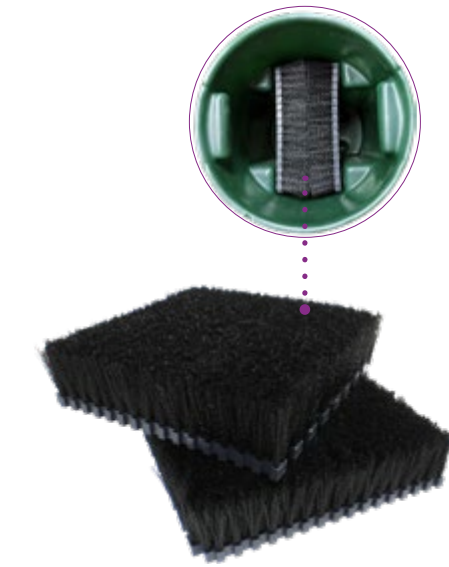

Club Washer Brush [No. 405]

CHIPPING GREENS BALL PUSHER

This easy to use ball pusher is perfect for the practice chipping green. It allows golfers to sweep balls quickly and effectively.



Chipping Greens Ball Pusher [No. 132]

PRACTICE AND RANGE

RANGE BANNERS

Range Banners made of heavy duty dye-sublimated (no peeling) polyester and durable PVC pipe. Numbered 25-300 in 25 yard increments. Some assembly required.



YARDAGE	BANNER ONLY		COMPLETE UNIT	
	VERTICAL	HORIZONTAL	VERTICAL	HORIZONTAL
25 YDS	VRB025	RB025	COMVRB025	COMRB025
50 YDS	VRB050	RB050	COMVRB050	COMRB050
75 YDS	VRB075	RB075	COMVRB075	COMRB075
100 YDS	VRB100	RB100	COMVR100	COMRB100
125 YDS	VRB125	RB125	COMVR125	COMRB125
150 YDS	VRB150	RB150	COMVR150	COMRB150
175 YDS	VRB175	RB175	COMVR175	COMRB175
200 YDS	VRB200	RB200	COMVR200	COMRB200
225 YDS	VRB225	RB225	COMVR225	COMRB225
250 YDS	VRB250	RB250	COMVR250	COMRB250
275 YDS	VRB275	RB275	COMVR275	COMRB275
300 YDS	VRB300	RB300	COMVR300	COMRB300

Horizontal and Vertical Range Banners - Complete Units or Banners Only

Framing Kit Only [No. RBKIT]



Sand/Seed Bottle w/ Handle
Part No. 234H
Page 11

Recycled Plastic Bench
Part No. EE1214
Page 15

Double Brush Stand
Part No. 686
Page 68

SPIKE CLEANER STANDS & MOUNTS	68
REPLACEMENT BRUSHES	68
ASSEMBLIES	68
OTHER FURNITURE	69
ECO BLAST AIR HORNS	69
PROXIMITY MARKERS	70
UNIVERSAL FLAG HOLDER	70

SPIKE CLEANER STANDS AND MOUNTS

The brush spike cleaner stands are constructed of 1" steel tubing with flange base. The base can be secured to a hard surface with lag bolts, or onto grass/other ground surface with four 6" long spikes (all necessary hardware is provided).



Double Brush Spike Cleaner Stand [No. 680 or 680BK for black flange]



Double Brush Spike Cleaner Stand with Side Brushes [No. 687 or 687BK for black flange]

Single or double mount with spike cleaner brushes. Wraps around our ball washer ensemble 2" pipe. Available unpainted only.

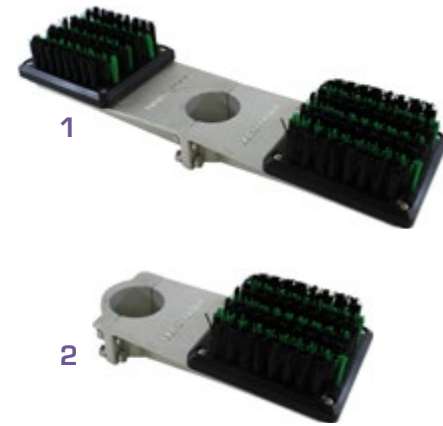

**1. Double Mount with Brushes [No. 675]
2. Single Mount with Brush [No. 670]**

BRUSH ASSEMBLIES

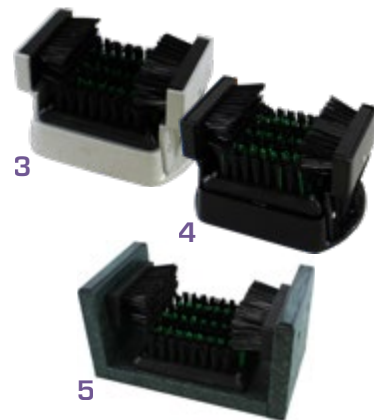

**3. Brush Assembly w/ Side Brushes [No. 606]
4. Black Brush Assembly w/ Side Brushes [No. 606BK]
5. Recycled Plastic Brush Assembly [No. E601] (comes with spikes)**



**6. Brush Assembly [No. 600] Holder Only [No. 605]
7. Black Brush Assembly [No. 600BK] Holder Only [No. 605BK]**

REPLACEMENT BRUSHES



**8. Side Brush w/ Hardware [No. 606-2]
9. Base Brush w/ Hardware [No. 610]**
Brush screws into 701 Base.

OTHER PRO-SHOP & CLUBHOUSE FURNITURE



Modular golf bag rack made of durable heavy duty metal with powder coated finish. They can be assembled to any length in multiples of 3', or be set back to back. Sold as a pack of two racks, holds up to 6 golf bags. All necessary hardware included.
No. 780BK shown in photo.

**Golf Bag Racks [No. 780BK] (double)
Golf Bag Racks [No. 780BK-1] (single)**

AIR HORNS

Eco-Blast Air Horns are powerful, USGA approved sound emitters that can be recharged with almost any pump. They both emit approx. 115-120 dB.

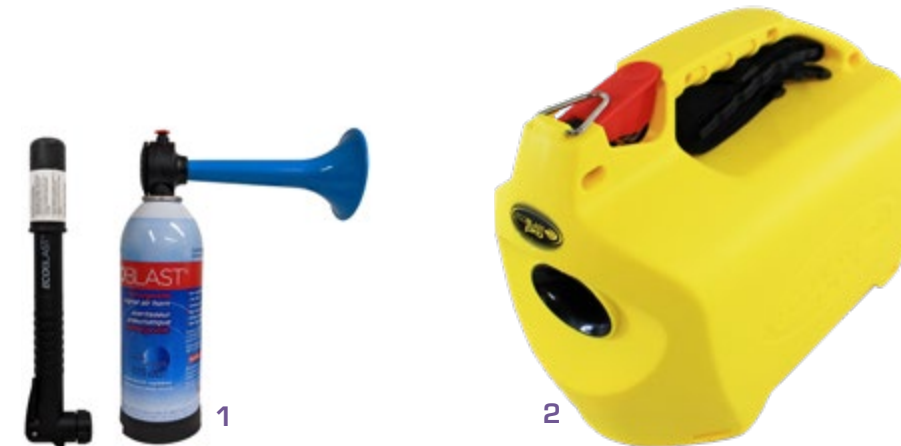

**1. Eco-Blast Air Horn [180] (comes with pump)
2. Eco-Blast Air Pro Horn [180PRO] (can be recharged w/ most pumps)**

A 12 prong litter stick with a quick release trigger. Made with durable aluminum handle and hard, heavy duty plastic.

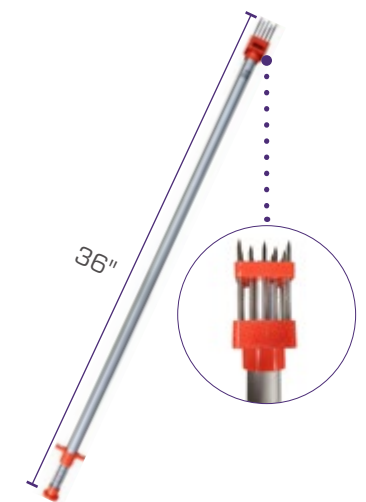

E-Z Litter Stick (WQL) [No. EZL3612]

PROXIMITY MARKERS

Sturdy nickel plated metal frame complete with 25 cards (double sided). Refill cards are available in pack of 25.

Pack of four Proximity Markers, each complete with its own pack of 25 cards.

Double sided, thick cardboard Proximity/Long Drive cards. Pack of 25.



Proximity Markers [No. 517WH]

Proximity Markers - 4 pack [No. 517WH-4]

Proximity/Long Drive Cards [No. 517-2]

UNIVERSAL FLAG HOLDER

Our Universal Flag Holder allows you to attach a flag to virtually any cart. It features a 2' white pole and either a 6x8" (DS) or 14x20" (SS) handicap flag.

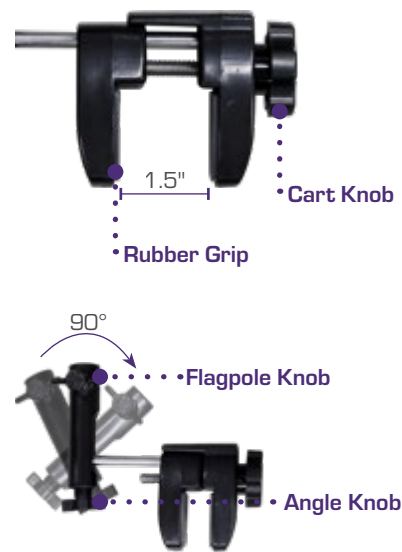

Would you like a different pole or flag? Purchase the holder only and/or the rod only separately. Please contact us for more information.



Universal Flag Holder with Flag
 6x8" Handicap Flag [No. 346HDCP-1]
 14x20" Handicap Flag [No. 346HDCP-2]
 6x8" Canadian Flag [346CANT]
 6x8" American Flag [346AMERT]

Other flags can be attached, as well.

1. Rod Only [No. 346ROD]
2. Universal Holder Only [No. 346]

CLEARANCE
SALE

UP TO
50% OFF

CLEARANCE

Please contact us for the most up to date availability of clearance items.

Made of cast aluminum and powder coated black, this mount allows you to install the litter bins to any wall. Hardware not included.



Litter Bin Wall Mount [No. 749]

Made of strong plastic, this placement marker slides onto the flag poles. It is equipped with a rubber ring which holds the ball in place.

● Blue ● Red ○ White



Plastic Placement Markers [No. 324]

Made of cast aluminum and powder coated black, with an unpainted or black reel. Rope extends up to 25' in length and the reel automatically collects the rope.



EZ Aluminum Rope Stakes

Height:	Unpainted Reel	Black Reel
24"	284UP	284BLACK
40"	285UP	285BLACK

Maintenance free, UV resistant, plastic markers. Cross-shaped structure with beveled tip makes for easy installation & replacement.

● Blue ● Red
● Yellow ○ White

● Blue ● Red
● Yellow ○ White



SMP Fairway Distance Markers [No. 293]

Our 5" solid plastic tee marker, but with the added bonus for a customized decal.

● Yellow ● Red
● Blue ● Black



Customizable Solid Tee Marker [No. 813]

Replacement SMP Parts

1. Replacement Stake [No. 293-01]
2. Replacement Base [No. 293-02]

ABOUT BAYCO

Our Name Stands for *Quality*

Bayco Golf started out unlike the typical business. The founder, Alex Colonelo, came from a mechanical toolmaker background. He started working at a company called Bay Bronze Industries which manufactured fuel fittings and plumbing parts as well as bronze signs and plaques. His passion for golf and his experience in manufacturing inspired him to start a golf course accessories division within Bay Bronze in 1986 (renamed to Colon Industries at this time). In 1998, he bought off the golf division and named the company Bayco Golf Inc where he became a president. He retired in 2006 when OSC Seeds purchased Bayco Golf and a new general manager, Cal Surgenor, was appointed. Cal has guided the continuing growing process of Bayco for over 15 years.



Bayco Golf has always strives to bring the best quality of products to the golf course accessory market. With our knowledgeable team and many years of experience, you can remove all uncertainty with anything related to your course. We build meaningful relationships with clients that last a lifetime. We pride ourselves that almost all of our products are manufactured locally in North America. We are a forward thinking, market improving company that has set the bar for numerous products, including Dye Sublimated Custom Flags, Pro Hole Cups with Liner and Locking Ferrule, ColorFlex Distance Markers, the Mully Cup Lifter, our newly designed InstaFix Ball Mark Repair Tool, and so much more.

The little train that could – did. We are one of the top manufacturers/suppliers in the world. We ship internationally in over 50 countries and our products are found on the most prestigious golf courses in the world. We design custom flags, markers, cup liners, plaques, signs and more! Our customers vary from a private individual who wants to build a small putting green in their back yard, to 36-hole resort golf courses around the world.

If you are looking for a reliable and knowledgeable staff to help you with your golf course accessory needs, look no further! Call us today and we would be happy to help you!

Get on course with **BAYCO!**

INDEX

A		
Aluminum Club Washers		
Aluminum Club Washer	8	
Flanged Base	8	
Replacement Brush	8	
B		
Ball Washers		
Ball Washer Wall Mount	7	
Crank & Plunger Style Repair Kit	7	
Ensemble Examples	3	
Model 699 Plunger Style Ball Washer	5	
Model 700 Plunger Style Ball Washer	5	
Model 770 Customizable Plunger Style Ball Washer	5	
Model 778 Crank Style Ball Washer	6	
C		
Clearance		
Customizable Solid Tee Marker	72	
EZ Aluminum Rope Stakes	72	
Litter Bin Wall Mount	72	
Plastic Placement Markers	72	
SMP Fairway Distance Markers	72	
Coco Drag Mat	43	
Cups		
Aluminum Cups		
4.25x4.25" Aluminum Greens Cup	30	
6x4.25" Aluminum Green Cup	30	
6x4.25" Aluminum Pro Hole Cup	31	
6x6" Temporary Aluminum Greens Cup	30	
Aluminum Cup Setter	32	
Cup Pullers		
Double, Single, Triple Prong Cup Puller	29	
Curved Trimming Scissors	29	
Green Plastic Cup Cover	v, 32	
Hole-In-White		
Paint Applicator	29	
Plastic Cups		
4.25x4.25" Plastic Greens Cup	30	
6x4.25" Plastic Cup with Bronze Insert	30	
6x4.25" Plastic Greens Cup	30	
SpeedWrap Cup Liners	31	
Cup Sleeves	32	
D		
Detergents		
Heavy Duty Detergent & Soap Tablets	iii,8	
Dew Whipping Pole	43	
Divot Mix / Sand and Seed		
Divot Mix Containers	10	
Personal Sand and Seed Bottle	11	
Plastic Scoops	10	
Rattle Proof Sand and Seed Bottle	11	
Rattle Proof S&S Bottle with a Metal Handle	11	
Rattle Proof S&S Bottle with Molded In Handle	11	
Replacement Screw-On Caps	11	
Sand and Seed Bottle Holder	11	
Sand and Seed Bottle Rack	10	
E		
Eco-Blast Air Horns	69	
Ensembles		
Ball Washer Stand Base	6	
Ensemble Examples	3	
Foot Brush with Screws	7	
Stainless Steel Spikes for Base	7	
Stand Pipes	6	
F		
Fairway Markers		
Color Flex Distance Markers	23	
Color Flex Installation Kit	23	
Color Flex Replacement Markers	23	
Domed Aluminum Distance Marker	23	
Domed Polymer Distance Marker	23	
Recycled Plastic Hazard Markers	23	
Flagpoles		
Bayco Guard for Flag Poles	36	
Flag Pole Holder Kit - American	37	
Flag Pole Holder Kit - Canadian	37	
Flag Pole Holder Only	37	
Mully Cup Lifter	36	
Reflectors		
Bayco Laser Reflectors	36	
Elite Laser Reflector	36	
DIY Laser Reflector	36	
Flags		
6x8" Checkered Tube Flags	63	
6x8" Country Tube Flags	63	
6x8" Numbered Tube Flags	63	
6x8" Nylon Tube Flags	63	
14x20" Checkered Tube Flags	39	
14x20" Country Flags	38	
14x20" Numbered Tube Flags	39	
14x20" Nylon Tube Flags	38	
14x20" Special Event Flags	39	
18x26" Checkered Tube Flags	63	
18x26" Nylon Tube Flags	63	
Custom Flags	41	
Flag Accessories		
Acorn Nut	38	
Quick Click	38	
Security Nut	38	
Furniture		
Benches		
5' Deco Bench	15	
6' Deco Bench	15	
6' Standard Bench	15	
Golf Bag Racks	69	
Water Coolers		
4 oz Solo Cups	15	
5 Gal. Water Cooler	14	
10 Gal. Water Cooler	14	
Lever Style Spigot	15	
Lock and Key	15	

INDEX

Pinch Tube Spigot	15	
Plastic Bracket	15	
Plastic Cup Dispenser	15	
Push Button Spigot	15	
Steel Bracket	15	
Steel Cup Dispenser	15	
G		
Greens Speedmeter	43	
H		
Hole Cutters		
Black Hole Cutter Guide	28	
Hole Cutter Flanged Stop	28	
Lever Style Hole Cutter	28	
Replacement Blades	28	
Wide Hole Cutter	28	
I		
InstaFix Ball Mark Repair Tool	43	
L		
Litter Baskets and Bins		
Designer Series Litter Bin	13	
Designer Series Litter Bin Lids	13	
Designer Series Litter Bin Mounting Brackets	13	
Designer Series Litter Bin Stands	13	
Litter Baskets & Bases	12	
Litter Basket Stand Base Mount	12	
M		
Maintenance		
Aluminum Landscaper	58	
E-Z Litter Stick	69	
E-Z Reacher	59	
Greens Section Soil Sampler	56	
Plug Pusher	59	
Roller Squeegee	58	
SOLO Back Pack Sprayer	59	
P		
Paint and Marking		
Marking Pistol	25	
Marking Wand	25	
Rust-Oleum Precision Line Marking	25	
Practice and Range		
Chipping Greens Ball Pusher	64	
Driving Range		
18x26" Checkered Tube Flags	63	
18x26" Nylon Tube Flags	63	
Club Washer Brush	64	
Range Banners	65	
Range Club Washer	64	
Practice Greens		
6x8" Checkered Tube Flags	63	
6x8" Country Tube Flags	63	
6x8" Numbered Tube Flags	63	
6x8" Nylon Tube Flags	63	
Chrome & Plastic Bases	62	
Gimme PG Markers	62	
Javelin Practice Greens Poles	62	
Practice Greens Flag Poles	62	
Proximity Markers	70	
R		
Rope		
Bungee Rope	24	
Custom Rope Stakes	24	
Recycled Plastic Rope Stakes	24	
Three Strand Braided Rope	24	
S		
Sand Trap Rakes		
Bayco Shrink Guard for Rake Handles	42	
Disc Tooth Rake Head	42	
Fiberglass Handle	42	
Lightweight Rake Head	42	
Octagon Rake Head	42	
Wooden Handle	42	
Signage		
ACP Custom Signs	50	
Aluminum Spikes	53	
Customizable Aluminum Signs	53	
Heavy Duty Steel Signs	52	
Two Sided Aluminum Directional Signs	53	
Spike Cleaners		
Brush Assemblies	68	
Double Brush Spike Cleaner Stand	68	
Double Brush Spike Cleaner Stand with Side Brushes	68	
Double Mount with Brushes	68	
Replacement Brushes	68	
Single Mount with Brush	68	
T		
Tee Markers and Caddies		
Broken Tee Caddies		
Aluminum Broken Tee Caddy	16	
Plastic Broken Tee Caddy	16	
Recycled Plastic Broken Tee Caddy	16	
Tee Markers		
3" Solid Plastic Tee Marker	18	
5" Custom Solid Tee Marker	19	
5" Hollow Plastic Tee Marker	18	
5" Hollow Tee Marker w/ Plastic Base	19	
5" Solid Plastic Tee Marker	18	
Recycled Plastic Cube Tee Markers	19	
Solid Aluminum Tee Marker	17	
Tear Drop Tee Marker	17	
Tee Towels		
Classic Tee Towel	14	
Cotton Corner Grommet Tee Towel	14	
Elite Cotton Center Grommet Towel	14	
Premium Tee Towel	14	
Tri-Fold Cotton Central Grommet Towel	14	
U		
Universal Flag Holder for Carts	37, 70	
W		
White Plastic Cup Collar	iii, iv, 29	

Get on course with **BAYCO!**

Customize your golf course accessories for 2024.
With a range of flags, tee markers and signs, you will find the right product to make your course stand out.

877.668.4653
BaycoGolf.com

www.BAYCOGOLF.com



BAYCO GOLF
206 Saulteaux Cres.
Winnipeg, MB R3J 3W3
Ph: (204) 633-8881
Fax: (204) 633-6226
E-Mail: contact@baycogolf.com

DISTRIBUTED BY:

RETURN POLICY

Bayco Golf strives for complete customer satisfaction at all times, however, in the unlikely event you are not completely happy with your purchase you may request a refund. All refund requests must be made within 7 days of delivery date. Please include your invoice number and name when contacting us. All items must be in a new/unused condition, in original packaging, and with all paperwork, parts, and accessories. Once the merchandise has been received and passed a satisfactory inspection, a refund will be issued onto the original method of payment and in the original currency (less the outbound and inbound shipping fees, where applicable). All returned items are subject to a \$10 restocking fee.

Exchange of items is only accepted if the item is damaged or has manufacturer's defects (proof upon request is needed). In this case, Bayco Golf will cover the shipping costs. If the item cannot be repaired, we will replace the item and send it back to the Customer at our own expense.

Exception to items include:

- Clearance Items – these are discontinued items that we wish to sell out of. We regret to say that items purchased as "Clearance" are not eligible for returns or exchanges.
- Custom Items – Custom items cannot be resold and therefore we cannot accept returns on them. Please note that it is the **Customer's responsibility** to ensure clarity in communication and to approve provided proofs for custom work. However, if a mistake is made on our end, Bayco Golf will re-do and replace the merchandise at no expense to the customer.
- Any other item that cannot be re-sold, that includes but is

not limited to items in used condition that do not qualify for our warranty or items reduced due to damage or defect and marked as final sale.

We reserve the right to warn, limit or decline returns or exchanges regardless if the item answers to all the conditions mentioned above. Notwithstanding, we may change or modify the agreement in part or completely without notice and we will not be held responsible for any loss or damage suffered as a result of such changes.

WARRANTY

Bayco Golf warrants products to be free from defects in materials and workmanship under correct use and proper applications for a period of six (6) months or one golf season from the original date of purchase. Warranty requests must be made immediately upon finding a defect and proof must be provided. The suitability whether the merchandise satisfies the conditions of the warranty are determined entirely by Bayco Golf. After passing a satisfactory inspection and concluding that the damage falls under the warranty, Bayco Golf's obligations are limited to the repair or exchange of the item at no cost to the client. Should the merchandise not satisfy the conditions of the warranty, Bayco Golf reserves the right to refuse or otherwise limit the return/repair/exchange of the item. **The warranty does not cover damages due to negligence, improper use or maintenance, weather conditions, theft, or natural disasters.**